

Nov. 2, 1965

R. L. TANNER

3,215,937

EXTREMELY LOW-FREQUENCY ANTENNA

Filed Aug. 27, 1962

3 Sheets-Sheet 1

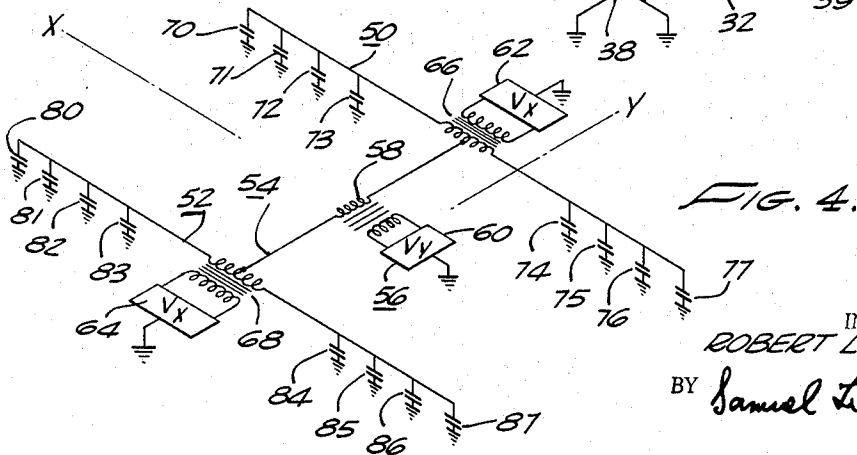
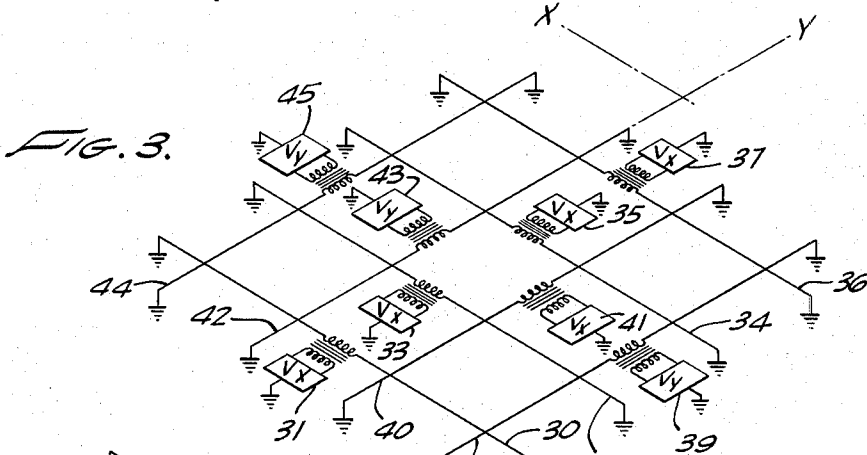
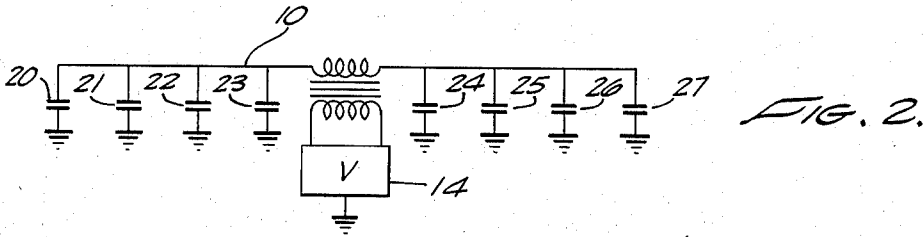
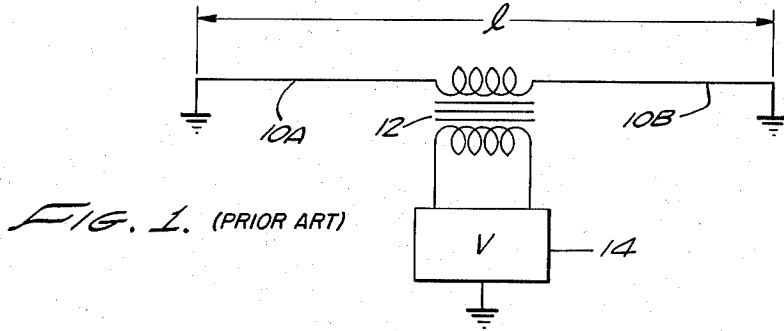

INVENTOR.  
ROBERT L. TANNER  
BY Samuel Lundenberg  
ATTORNEY

Nov. 2, 1965

R. L. TANNER

3,215,937

EXTREMELY LOW-FREQUENCY ANTENNA

Filed Aug. 27, 1962

3 Sheets-Sheet 2

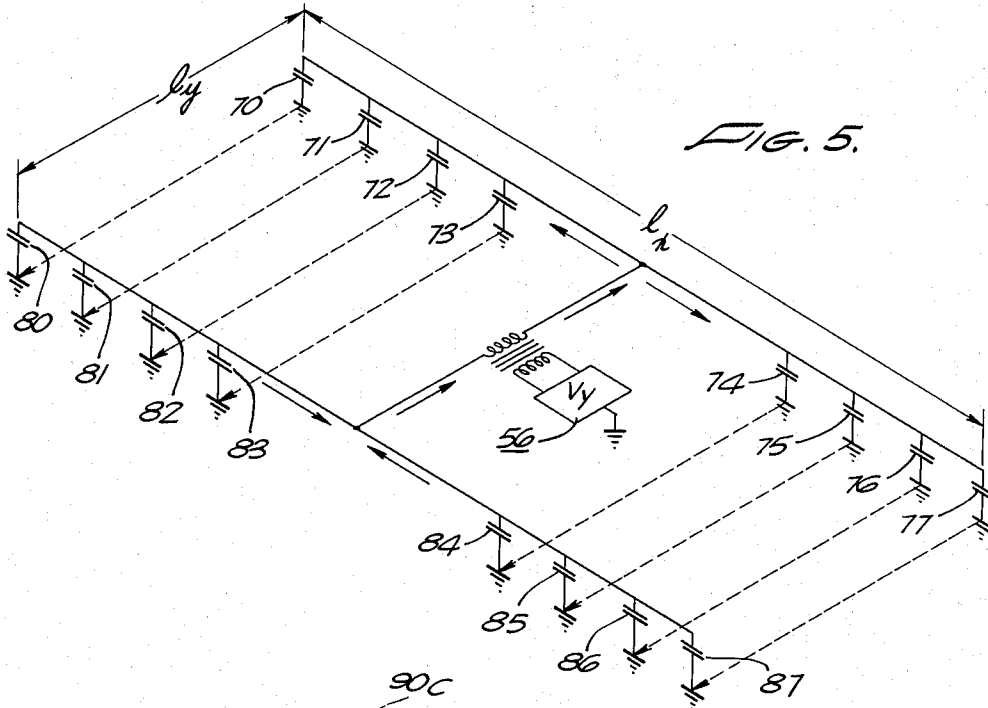

FIG. 5.

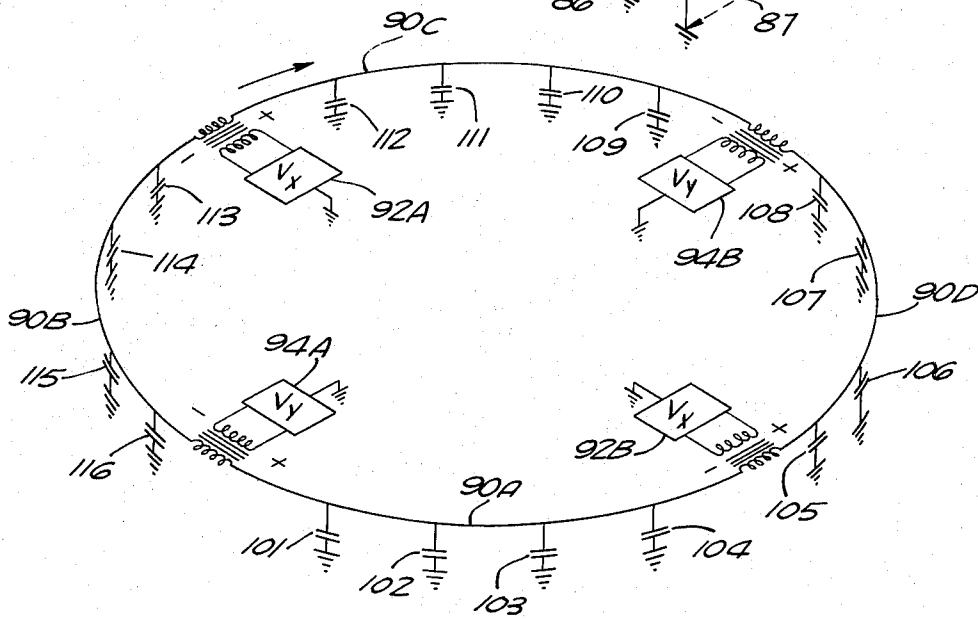

FIG. 6.

INVENTOR.  
ROBERT L. TANNER  
BY Samuel Lindenberg  
ATTORNEY

Nov. 2, 1965

R. L. TANNER

3,215,937

EXTREMELY LOW-FREQUENCY ANTENNA

Filed Aug. 27, 1962

3 Sheets-Sheet 3

FIG. 7.

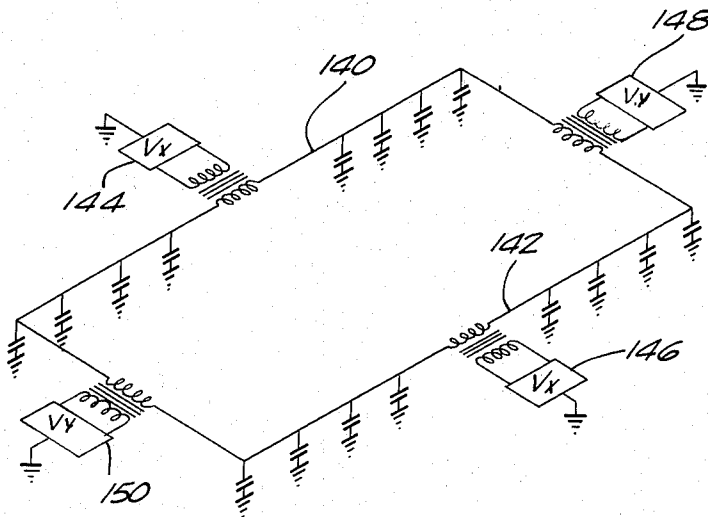
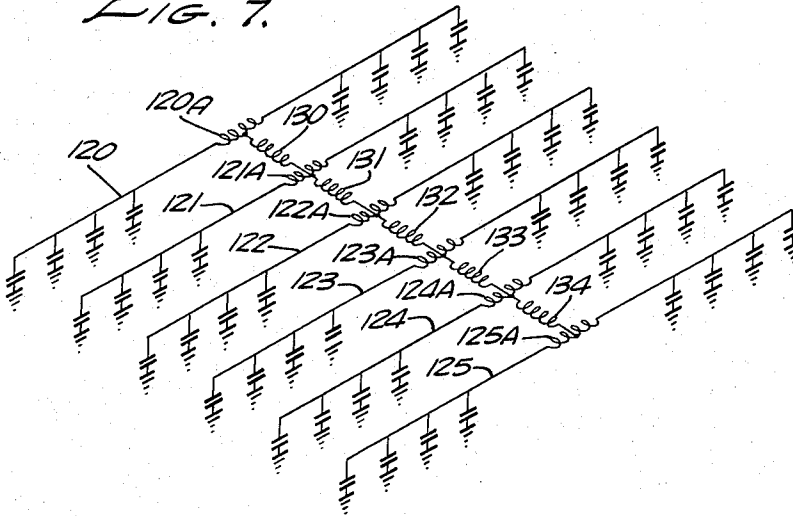

FIG. 8.

INVENTOR.  
ROBERT L. TANNER  
BY Samuel Lundberg  
ATTORNEY

3,215,937

**EXTREMELY LOW-FREQUENCY ANTENNA**

Robert L. Tanner, Menlo Park, Calif., assignor, by mesne assignments, to Control Data Corporation, South Minneapolis, Minn., a corporation of Minnesota

Filed Aug. 27, 1962, Ser. No. 219,699

8 Claims. (Cl. 325-28)

This invention relates to antenna systems, and more particularly, to improvements in antennas which are to be used with extremely low-frequency excitation.

The frequency range of extremely low frequencies is defined as those frequencies at which the wavelength is so long that the spacing between the parallel conducting surfaces formed by the earth and the ionosphere is only a small fraction of a wavelength. These frequencies embrace the range below approximately 1000 cycles per second. Interest has been aroused in transmitting at these frequencies because of their low attenuation, their stability of propagation under ionospheric conditions adversely affecting other frequencies and modes of propagation. Extremely low frequencies will hereafter be referred to by "ELF."

The major impediment to the use of ELF waves for communication is the difficulty of launching the waves. Waves of these frequencies are constrained by the boundary conditions provided by the earth and the ionosphere to propagate as vertically polarized waves. The traditional method of launching vertically polarized waves is by use of vertically oriented current-carrying structures or antennas. To be effective, however, these antennas must have heights which are not completely negligible when compared to the wavelength. At the frequencies with which this invention is concerned, however, the wavelengths are so great that the highest structures yet made by man would be completely ineffective as antennas. There are circumstances, however, under which horizontal structures will couple to the propagating wave. Since there is virtually no practical limit upon the length of horizontal structures which can be built, it is possible to launch ELF waves by this means. For the frequencies being considered, the earth and the ionosphere both have in general the properties of relatively good conductors. The spacing between them, however, is a rather small portion of a wavelength, so that the only mode which will propagate in the intervening space is that corresponding to the transverse electro-magnetic, or TEM mode in a parallel-plate transmission line; all higher-order modes are cut off and therefore do not propagate.

If the earth itself were a perfect conductor, the electric field at its surface would be exactly perpendicular; there would be no tangential component; and the only possible usable antenna would be one with a large vertical dimension. Actually, the picture of a TEM wave propagating between parallel-plate conductors is only an approximation. There are in reality finite tangential components of the field at the surface of the earth. The relative magnitudes of these tangential, or horizontal, fields depends upon the geological circumstances and can be expected to vary widely from one region to another. To obtain an idea of the circumstances under which horizontal fields might be expected to exist, if the analogy with a parallel-plate transmission line is examined, it will be seen that if one of the plates or a substantial area of one of the plates is composed of a relatively poor conductor, then over this area the electric-field lines are bent, introducing a tangential component. Another circumstance which can cause the introduction of a substantial tangential field component is if one of the plates is overlaid by a sheet of dielectric material. At the top

surface of the dielectric overlay an appreciable horizontal field component will exist. Still a third circumstance which gives rise to horizontal field components is to have a hole cut in one of the plates and the hole filled with a dielectric or very poor conductor. Counterparts of the conditions described exist in nature, and thus the horizontally disposed antenna over land having the counterpart characteristics can be successfully operated in the ELF frequency range.

Because of the low efficiency of an antenna operating in the ELF frequency range, it is important to minimize losses of any and all types which can serve to cut down further the efficiency of the antenna. Another problem that arises with ELF antennas occurs when it is sought to obtain an omni-azimuthal-radiation pattern. Since the length of a wavelength at the frequencies of interest may be on the order of thousands of miles, in constructing an antenna, it will be desirable to make it as long as is economically feasible. Thus, for example, an antenna for ELF can consist of a conductor or a number of parallel conductors which are on the order of 150 to 200 miles long and which are excited at their centers. However, the radiation pattern of such conductor is basically a figure eight. An omni-azimuthal-radiation pattern can be obtained by using two separate antenna systems oriented 90° spatially from one another and excited with generators having a voltage-phase difference of 90°. To do this, however, requires more than one antenna system, and, in view of the cost of a single-antenna system of this type, can become extremely expensive.

Accordingly, it is an object of this invention to provide a novel arrangement for an ELF antenna system.

Another object of the present invention is the provision of an ELF antenna system having an improved efficiency.

Yet another object of the present invention is the provision of a unique ELF antenna system wherein ground losses are reduced.

Still another object of the present invention is the provision of an omni-azimuthal ELF antenna system which is less expensive than previously known systems.

These and other objects of this invention may be achieved by connecting different reactive impedance, such as a capacitor or inductor, between each of different spaced points along conductors employed as an ELF antenna and ground. An omni-azimuthal-radiation pattern may be obtained with an ELF antenna, in accordance with this invention in one embodiment by employing two or more lines of the type just described which are spaced on the order of four times the skin depth of penetration into the earth apart from one another. This spacing is not required as a condition of operation, but yields maximum performance for a given installation cost. In its simplest form, the two lines composing the antenna can then be excited by generators close to their centers with one phase, and from a generator which is connected to both centers in phase quadrature.

In another embodiment, the conductor which is employed is disposed in a closed geometric figure, rather than by an open line. Such a figure may be, for example, a circle. This line is connected to ground at spaced points therealong through a different reactive impedance, such as a capacitor or inductor, in the manner described for the previous embodiment of the invention. At least four locations which are spaced approximately equally around the perimeter of the figure described by the antenna conductor, generators are coupled to the antenna to apply excitation thereto. An opposite two of these generators apply excitation to the antenna in phase quadrature to the excitation applied

from the remaining opposite two generators. The resultant radiation pattern is omniazimuthal.

The novel features that are considered characteristic of this invention are set forth with particularity in the appended claims. The invention itself, both as to its organization and method of operation, as well as additional objects and advantages thereof, will best be understood from the following description when read in connection with the accompanying drawings, in which:

FIGURE 1 is a schematic drawing of a known antenna arrangement, shown to provide a better understanding of this invention;

FIGURE 2 is a schematic drawing, showing how the antenna of FIGURE 1 can be improved in accordance with the teachings of this invention;

FIGURE 3 is a schematic drawing of an omniazimuthal antenna in accordance with the presently known teachings;

FIGURE 4 is a schematic drawing of an omniazimuthal antenna in accordance with this invention;

FIGURE 5 is a schematic drawing showing current flow associated with the antenna in response to the excitation by a single generator; and

FIGURE 6 is a schematic drawing of another embodiment of this invention.

FIGURES 7 and 8 are schematic drawings of other embodiments of this invention.

Referring now to FIGURE 1, there may be seen an antenna system of a known type which is suitable for radiating waves in the ELF range. This includes a conductor of length  $L$ . The conductor is divided into two halves, respectively 10A, 10B. One end of each half is grounded, and the other ends of each half are connected to any suitable arrangement for being fed with a voltage, which is illustrated as a transformer 12, connected to a source of energizing voltage 14. The voltage applied to the antenna will cause current to flow along one half, into the ground, through the ground to the opposite ground connection point, and thence back to the point of origin, which is the secondary winding of transformer 12. Losses occur in the ground path between the ends of the antenna, in the grounding connection at the antenna ends, and as copper losses in the wires themselves. Although copper losses cannot be neglected, they can be accounted for simply, and will be ignored in the present discussion. The radiation patterns of the antenna shown in FIGURE 1, as well as the antenna shown in FIGURE 2, is a simple figure eight, with the maxima occurring off the ends of the antenna.

In FIGURE 2 there is shown an arrangement for increasing the electrical length of the antenna without increasing its actual physical length. This is done by connecting a plurality of capacitors, respectively 20 through 27, between spaced points along the conductor 10 to ground. The capacitors provide a plurality of grounding connections for the antenna. They thereby reduce the current density of the current entering the ground at any one location, and thus reduce the loss in the grounding connection. By appropriate choice of the number and the value of the capacitors, the antenna is made to approximate a uniformly loaded line of one-half wave length electrical length. It is consequently resonant and presents a resistive impedance to the generator. This arrangement yields maximum bandwidth at maximum efficiency. Appropriately chosen inductors can be used in place of the capacitors to cause the current to enter the ground at points distributed over the length of the antenna and thereby to achieve reduced ground losses and higher efficiency than the antenna of FIGURE 1. Use of inductors rather than capacitors results in restricted bandwidth and a somewhat lower efficiency, however.

As has been indicated, the basic radiation pattern of the antenna configuration shown in FIGURES 1 and 2

are figure eights. Complete azimuthal coverage can be obtained, however, by using two separate antenna systems oriented  $90^\circ$  spatially from one another, and excited with generators having a voltage-phase difference of  $90^\circ$ . This is schematically illustrated in FIGURE 3. A plurality of spaced antennas, respectively 30, 32, 34, 36, 38, 40, 42, and 44. The excitation sources indicated as  $V_x$ , and having the respective reference numerals 31, 33, 35, and 37 applied thereto, are excited in quadrature with the  $V_y$  excitation sources, respectively 39, 41, 43, and 45.

The means for obtaining omniazimuthal coverage, which is shown in FIGURE 3, requires separate antenna systems. In accordance with this invention, as shown in FIGURE 4, the same result can be obtained with a single-antenna system, thereby achieving a saving of fifty percent in the cost of the antenna. This result is achieved by operating the single antenna in two modes. Effectively, what is shown in FIGURE 4 comprises two simple antennas, 50, 52, of the type shown in FIGURE 2, which are interconnected in the manner shown in FIGURE 4. These antennas 50, 52 have their centers connected by a line 54, whereby they may be excited from a source 56, which includes the coupling transformer 53, driven by the  $V_y$  voltage generator 60. At the centers of the antenna conductors 50 and 52 there are connected excitation sources, respectively 62, 64, these sources are balanced and center-tapped, indicated schematically in the figure by the respective transformer 66, 68 with center-tapped secondary windings.

To those skilled in the art it is evident that as a result of the well known superposition principle which applies to electric fields and circuits, the effect of source 56, can be considered independently from the effect of sources 62 and 64. If we now consider the effect of sources 62 and 64, alone, we see that we have two antennas similar to the antenna of FIGURE 2 operating in parallel. Provided that the antennas are spaced sufficiently far apart to minimize mutual effects (a spacing or the order of four times the skin depth is adequate for this purpose), the two element antenna array has a pattern essentially identical to the pattern of the antenna of FIGURE 2, but the efficiency is doubled. This increased efficiency is obtained by reducing the total effective loss resistance by a factor of two, while leaving the radiation resistance unaltered.

Each one of the antenna lines 50, 52 is connected to ground at spaced points along the conductors by means of the respective capacitors, respectively 70 through 77, 80 through 87. As pointed out previously, the values of the capacitance should be selected to tune the antenna to resonance, if possible. The number of capacitors which may be employed is determined by the economics of the situation, since these antennas may have lengths as great as 200 or 300 miles. Inductors may be employed in place of the capacitors, but for the reasons given previously capacitors are preferred.

FIGURE 5 is a schematic drawing of the antenna shown in FIGURE 4, considering solely the Y mode of operation and the current distribution for that mode, which again, as a result of the superposition principle, can be considered independently from the X mode. The distributed-tuning capacitors, respectively 70 through 77 and 80 through 87, are adjusted so that the current entering the ground is approximately uniformly distributed over the length of the conductors. The radiation resistance is given by:

$$R_{rv} = \frac{\pi Z_s^2 l_y^2}{4\eta_0 \lambda h}$$

where  $Z$  equals the magnitude of the surface impedance of the earth, over which the conductor is stretched, in ohms. Its value depends upon the conductivity of the earth and the frequency.  $\eta_0$  equals the intrinsic impedance of free space (377 ohms),  $l_y$  equals the length as indicated in FIGURE 5 in meters,  $\lambda$  equals the wave-

length in meters, and  $h$  equals the effective ionosphere height in meters.

Because  $l_y$  in the configuration illustrated is less than  $l_x$ , the radiation resistance as presented to the  $V_y$  generator is substantially less than that seen by the  $V_x$  generators. However, because the return currents, as shown by the dotted arrows in FIGURE 5, flow transverse to a long, narrow strip, the ground return resistance is greatly reduced also. It can be shown, in fact, that the loss resistances are reduced in approximately the same proportion as the radiation resistance so that the efficiency in the "y" mode is very nearly the same as in the "x" mode. The solid arrows in FIGURE 5 show the current-flow paths through the conductors, while the dashed arrows show the current-flow paths in the ground for this mode.

Reference is now made to FIGURE 6, which shows another arrangement in accordance with this invention for obtaining an omniazimuthal radiation pattern. Effectively, this comprises an antenna conductor disposed in a closed configuration. Although this configuration is shown, by way of example as a circle, this is not to be construed as a limitation upon the disposition of the conductor. For an excitation on the order of 40 to 200 cycles per second, the diameter of a closed figure will be between 100 and 300 miles. Effectively, the antenna comprises four substantially equal-length antenna conductors, respectively 90A, 90B, 90C, and 90D, which are coupled together by the respective excitation sources 92A, 92B, 94A, and 94B. Capacitors 101 through 116 are connected between spaced points along the antenna conductors 90A through 90D to ground. One function of these capacitors is, as has been previously described, to reduce the physical length of the conductor while extending its electrical length so that the antenna is tuned to present a resistive impedance to the generators and provide maximum operating bandwidth. The capacitors serve to provide a multiplicity of grounding points, whereby the loss due to earth contact resistance is minimized. The capacitors also serve to tune the antenna toward resonance, whereby its radiation efficiency is increased. As indicated previously, inductors may be used in place of capacitors, but capacitors are preferred.

Sources 92A and 92B apply excitation in phase to the opposite halves of the antenna. The polarity of this excitation is shown by the plus and minus signs on the drawing. As a result, there is current flow along antenna section 90C from the excitation source 92A out through the conductor from which it enters the ground returned by way of the capacitors 112, 111, 110, and 109. From these points the current flows through the ground to the ground connection points of capacitors 116, 115, 114, and 113, where it enters the conductor 90B, and returns by way of this conductor to source 92A. Similarly, current from source 92B out conductor 90D, into the ground by way of capacitors 105 through 108, through the ground to corresponding capacitors 101 through 104, into conductor 90A and returning thence to source 92B. From symmetry it is seen that current from sources 92A and 92B cancel in the secondary windings of the transformers associated with sources 94A and 94B so that there is no current from these sources at those points. The excitation of the conductors 90C and 90B and 90A and 90D, from the respective sources 92A and 92B provide a figure-eight pattern with its transverse axis extending through the antenna at the coupling locations of sources 92A and 92B, and the loops of the figure-eight extending along the line joining sources 94A and 94B.

Sources 94A and 94B excite the antenna with currents which are in phase with one another, but which are in quadrature with the excitation by sources 92A and 92B. Accordingly, considering the excitation from source 94A alone, current will flow out along conductor 90A, enter the ground through capacitors 101 through 104, flow generally along chords of the circle to conductor 90B enter this conductor through capacitors 113 through 116 and

return thence to the generator. Considering the excitation by source 94B, current will flow out along conductor 90D and return by way of capacitors 105 through 108 through the ground, and return to the generator by way of capacitors 109 through 112 and conductor 90C. Accordingly, another figure-eight pattern is provided which has its transverse axis substantially extending through the two coupling sources 94A and 94B and its loops lying along a line joining 92A and 92B. This second pattern is in phase quadrature with the first, so that the antenna shown in FIGURE 6 provides an omniazimuthal pattern.

While FIGURE 4 illustrates the embodiment of the invention using antenna conductors 50 and 52, this should not be considered as a limitation upon the invention since where desired, as is shown in FIGURE 7, a multiplicity of antenna conductors 120 through 125 may be used for radiating and receiving signals, all of which are excited simultaneously in two modes in the manner taught by FIGURE 4. Thus each of the conductors is excited in phase and in quadrature phase from its center by the same arrangement as is shown in FIGURE 4. To simplify the drawing only the secondary windings of the exciting transformers are shown. Thus center tapped secondary windings respectively 120A through 125A are connected at the centers of the respective conductors 120 through 125 and serve to apply not only in-phase excitation from  $V_x$  sources, not shown, but also quadrature  $V_y$  excitation from the transformer secondary windings 130 through 134 respectively connected between the center taps of transformers 120A through 125A.

In a similar vein, considering FIGURE 6 of the drawings, a multiplicity of antennas of the type shown may be employed. These antennas may be concentrically disposed relative to one another and may be simultaneously excited in phase and in quadrature phase to secure an omniazimuthal radiation pattern and twice the radiating power with one half the number of conductors.

Although the embodiments of the invention shown in FIGURES 4 and 7 show  $V_x$  and  $V_y$  excitation being applied at the centers of the antenna conductors, it is also possible to excite the antenna conductors from both the centers and the ends. Thus as shown in FIGURE 8 the antenna conductors 140, 142 are excited in the  $V_x$  mode by the respective generators 144, 146 from their centers and in the quadrature mode from the respective  $V_y$  generators 148, 150 connected at the opposite ends of the antenna conductors. It is evident additionally that the antenna of FIGURE 8 is similar to that of FIGURE 6 except that the circle in FIGURE 6 has been replaced by a rectangle.

There has accordingly been described and shown herein a novel, useful, and unique antenna system for radiating and receiving signals in an omniazimuthal pattern at extremely low frequencies. The bandwidth at these extremely low frequencies may be on the order of between two and twenty cycles. The novel antenna described herein provides an increased efficiency over those known heretofore, and it also provides an arrangement for reducing the cost of these types of antennas considerably for a given efficiency and pattern coverage.

In accordance with this invention the efficiency of an ELF antenna is increased because each antenna line is used twice in response to excitation from two quadrature phase related sources.

I claim:

1. An antenna for transmitting extremely-low-frequency signals comprising a first and second conductor extending along the earth, spaced parallel from one another for a predetermined distance, means for applying extremely-low-frequency excitation to each of said conductors substantially at their centers at a reference phase, means for applying extremely-low-frequency excitation to said conductors substantially at their centers at a phase which is shifted 90° relative to said reference phase, a plurality of reactive impedances, and means for connect-

ing a different one of said reactive impedances between spaced points along each of said conductors and ground.

2. An extremely-low-frequency antenna system as recited in claim 1 wherein said means for exciting each of said conductors with extremely-low-frequency excitation at a reference phase substantially at the centers of said conductors comprises at least two sources of excitation, means coupling the first of said sources of excitation to one of said two conductors at its center, means coupling the second of said sources of excitation to the other of said two conductors at its center, said means for exciting said conductors with extremely-low-frequency excitation at a phase which is shifted 90° from said reference phase comprises a source of quadrature excitation, and means for connecting said source of quadrature excitation between the centers of said two conductors.

3. An antenna for transmitting extremely-low-frequency signals comprising a first and second conductor extending for a predetermined distance over the surface of the ground, a plurality of capacitors, means for connecting a different one of said capacitors between spaced points along said conductors and ground, a first and second source of extremely-low-frequency excitation at a reference phase, means for coupling said first source of extremely-low-frequency excitation to the center of one of said two conductors, means for coupling said second source of extremely-low-frequency excitation to the center of said other of said two conductors, a third and fourth source of extremely-low-frequency excitation at a phase which is shifted 90° from said reference phase, means for coupling said third source of extremely-low-frequency excitation to two of the ends of said first and second conductors, means for coupling said fourth source of extremely-low-frequency excitation to the remaining two ends of said two conductors.

4. An antenna for transmitting extremely-low-frequency signals comprising two conductors spaced parallel to one another and separated by a distance equal on the order of four times the depth of penetration of the extremely-low-frequency signals into the ground, a plurality of capacitors, means for connecting said plurality of capacitors between said conductors and ground, each of said capacitors being spaced from the other, a first source of extremely-low-frequency excitation at a reference phase, means for coupling said source of extremely-low-frequency excitation between the centers of said two conductors, second and third sources of extremely-low-frequency excitation having a phase in quadrature with said reference phase, means coupling said second source of excitation to the center of one of said two conductors and means for coupling said third source of extremely-low-frequency excitation to the center of the other of said conductors.

5. An antenna for radiating extremely-low-frequency signals comprising a conductor describing a closed loop substantially parallel to the ground, a plurality of capacitors, means for connecting a different one of said capacitors between spaced points along said conductor and the ground, a first and second extremely-low-frequency source of excitation at a reference phase, means for coupling said first source of excitation to said closed loop at one point thereof, means for coupling said second source of extremely-low-frequency excitation to a diametrically opposite point of said closed loop, a third and fourth source of extremely-low-frequency energy having

a phase in quadrature to said reference phase, means for coupling said third source to a point of said closed loop which is between said first and second sources, and means for coupling said fourth source to a point on said closed loop which is diametrically opposite to said coupling of said third source.

6. An antenna for radiating extremely-low-frequency signals in an omniazimuthal pattern comprising a first and second conductor extending above the ground for a predetermined distance, a plurality of capacitors, means connecting a different one of said capacitors from a different point along each of said conductors to ground, said capacitors being spaced from one another along said conductors, first means for generating extremely-low-frequency signals at a reference phase, means for applying signals from said first means for generating to said first and second conductors, second means for generating extremely-low-frequency signals at a phase which is in quadrature with said reference phase, and means for applying signals from said second means for generating first and second conductors.

7. An antenna as recited in claim 6 wherein said first means for generating signals at said reference phase includes first and second sources of excitation, said means for applying signals from said first means for generating to said first and second conductors comprises first transformer means coupling said first source of excitation to the center of said first conductor, and second transformer means coupling said second source of excitation to the center of said second conductor, and said means for applying said signals from said second means for generating to said first and second conductors comprises means for applying signals from said second means for generating to said first and second transformer means.

8. An antenna as recited in claim 6 wherein said first means for generating signals at said reference phase includes first and second sources of excitation, said means for applying signals from said first means for generating to said first and second conductors comprises first transformer means coupling said first source of excitation to the center of said first conductor, and second transformer means coupling said second source of excitation to the center of said second conductor and said second means for generating extremely-low-frequency signals at a phase which is in quadrature with said reference phase includes third and fourth sources of excitation, said means for applying signals from said second means for generating to said first and second conductors includes third transformer means coupling said third source of excitation to one end of said first conductor and one end of said second conductor, and fourth transformer means coupling said fourth source of excitation to the other end of said first conductor and the end of said second conductor.

#### References Cited by the Examiner

##### UNITED STATES PATENTS

1,517,816	12/24	Alexanderson	343—745
1,595,166	8/26	Scheller	343—845
1,599,453	9/26	Affel	343—845
1,740,371	12/29	Rice	343—747

##### FOREIGN PATENTS

406,535 5/22 Germany.

DAVID G. REDINBAUGH, *Primary Examiner.*