

Note Outline: Geophysical Surveying Using Magnetism Methods

Introduction

- [Historical Overview](#)
 - [Similarities Between Gravity and Magnetism](#)
 - [Differences Between Gravity and Magnetism](#)
 - [Magnetic Monopoles](#)
 - [Forces Associated with Magnetic Monopoles](#)
 - [Magnetic Dipoles](#)
 - [Field Lines for a Magnetic Dipole](#)
 - [Units Associated with Magnetic Poles](#)
-

Magnetization of Materials

- [Induced Magnetization](#)
 - [Magnetic Susceptibility](#)
 - [Mechanisms of Magnetic Induction](#)
 - [Susceptibilities of Common Rocks and Minerals](#)
 - [Remanent Magnetism](#)
-

The Earth's Magnetic Field

- [Magnetic Field Nomenclature](#)
 - [The Earth's Main Field](#)
 - [Magnetism and Geology - A Simple Example](#)
 - [Temporal Variations of the Earth's Main Field - Overview](#)
 - [Secular Variations](#)
 - [Diurnal Variations](#)
 - [Magnetic Storms](#)
-

Magnetometers

- [Instrumentation Overview](#)
- [Fluxgate Magnetometers](#)
- [Proton Precession Magnetometers](#)
- [Total Field Measurements](#)

Field Procedures

- [Modes of Acquiring Magnetic Observations](#)
 - [Assuring High-Quality Observations - Magnetic Cleanliness](#)
 - [Strategies for Dealing with Temporal Variations](#)
 - [Spatially Varying Corrections?](#)
 - [Correcting for the Main-Field Contributions](#)
-

Magnetic Anomalies Over Simple Shapes

- [Comparison Between Gravity and Magnetic Anomalies](#)
 - [Magnetic Anomaly: Magnetized Sphere at the North Pole](#)
 - [Magnetic Anomaly: Magnetized Sphere at the Equator](#)
 - [Magnetic Anomaly: Magnetized Sphere in the Northern Hemisphere](#)
-

[FAQ](#)

[E-Mail](#)

[Home](#)

Introduction to Magnetic Exploration - Historical Overview



Unlike the gravitational observations described in the previous section, man has been systematically observing the earth's magnetic field for almost 500 years. Sir William Gilbert (left) published the first scientific treatise on the earth's magnetic field entitled *De magnete*. In this work, Gilbert showed that the reason compass needles point toward the earth's north pole is because the earth itself appears to behave as a large magnet. Gilbert also showed that the earth's magnetic field is roughly equivalent to that which would be generated by a bar magnet located at the center of the earth and oriented along the earth's rotational axis. During the mid-nineteenth century, Karl Frederick Gauss confirmed Gilbert's observations and also showed that the magnetic field observed on the surface of the earth could not be caused by magnetic sources external to the earth, but rather had to be caused by sources within the earth.

Geophysical exploration using measurements of the earth's magnetic field was employed earlier than any other geophysical technique. von Werde located deposits of ore by mapping variations in the magnetic field in 1843. In 1879, Thalen published the first geophysical manuscript entitled *The Examination of Iron Ore Deposits by Magnetic Measurements*.

Even to this day, the magnetic methods are one of the most commonly used geophysical tools. This stems from the fact that magnetic observations are obtained relatively easily and cheaply and few corrections must be applied to the observations. Despite these obvious advantages, like the gravitational methods, interpretations of magnetic observations suffer from a lack of uniqueness.



Similarities Between Gravity and Magnetics

Geophysical investigations employing observations of the earth's magnetic field have much in common with those employing observations of the earth's gravitational field. Thus, you will find that your previous exposure to, and the intuitive understanding you developed from using, gravity will greatly assist you in understanding the use of magnetics. In particular, some of the most striking similarities between the two methods include:

- Geophysical exploration techniques that employ both gravity and magnetics are passive. By this, we simply mean that when using these two methods we measure a naturally occurring field of the earth: either the earth's gravitational or magnetic fields. Collectively, the gravity and magnetics methods are often referred to as *potential methods**, and the gravitational and magnetic fields that we measure are referred to as *potential fields*.
- Identical physical and mathematical representations can be used to understand magnetic and gravitational forces. For example, the fundamental element used to define the gravitational force is the [point mass](#). An equivalent representation is used to define the force derived from the fundamental magnetic element. Instead of being called a point mass, however, the fundamental magnetic element is called a [magnetic monopole](#). Mathematical representations for the point mass and the magnetic monopole are identical.
- The acquisition, reduction, and interpretation of gravity and magnetic observations are very similar.

*The expression *potential field* refers to a mathematical property of these types of force fields. Both gravitational and the magnetic forces are known as *conservative forces*. This property relates to work being path independent. That is, it takes the same amount of work to move a mass, in some external gravitational field, from one point to another regardless of the path taken between the two points. Conservative forces can be represented mathematically by simple scalar expressions known as potentials. Hence, the expression potential field.



Differences Between Gravity and Magnetics

Unfortunately, despite these similarities, there are several significant differences between gravity and magnetic exploration. By-in-large, these differences make the qualitative and quantitative assessment of magnetic anomalies more difficult and less intuitive than gravity anomalies.

- The fundamental parameter that controls gravity variations of interest to us as exploration geophysicists is rock density. The densities of rocks and soils vary little from place to place near the surface of the earth. The highest densities we typically observe are about 3.0 gm/cm^3 , and the lowest densities are about 1.0 gm/cm^3 . The fundamental parameter controlling the magnetic field variations of interest to us, magnetic susceptibility, on the other hand, can vary as much as four to five orders of magnitude*. This variation is not only present amongst different rock types, but wide variations in susceptibility also occur within a given rock type. Thus, it will be extremely difficult with magnetic prospecting to determine rock types on the basis of estimated susceptibilities.
- Unlike the gravitational force, which is always attractive, the magnetic force can be either attractive or repulsive. Thus, mathematically, monopoles can assume either positive or negative values.
- Unlike the gravitational case, single magnetic point sources (**monopoles**) can never be found alone in the magnetic case. Rather, monopoles always occur in pairs. A pair of magnetic monopoles, referred to as a *dipole*, always consists of one positive monopole and one negative monopole.
- A properly reduced gravitational field is always generated by subsurface variations in rock density. A properly reduced magnetic field, however, can have as its origin at least two possible sources. It can be produced via an *induced magnetization*, or it can be produced via a *remanent magnetization*. For any given set of field observations, both mechanisms probably contribute to the observed field. It is difficult, however, to distinguish between these possible production mechanisms from the field observations alone.
- Unlike the gravitational field, which does not change significantly with time**, the magnetic field is highly time dependent.

*One order of magnitude is a factor of ten. Thus, four orders of magnitude represent a variation of 10,000.

**By this we are only referring to that portion of the gravity field produced by the internal density distribution and not that produced by the tidal or drift components of the observed field. That portion of the magnetic field relating to internal earth structure can vary significantly with time.



Magnetic Monopoles

Recall that the gravitational force exerted between two [point masses](#) of mass m_1 and m_2 separated by a distance r is given by Newton's law of gravitation, which is written as

$$F_g = \frac{G m_1 m_2}{r^2}$$

where G is the gravitational constant. This law, in words, simply states that the gravitational force exerted between two bodies decreases as one over the square of the distance separating the bodies. Since mass, distance, and the gravitational constant are always positive values, the gravitational force is always an attractive force.



Charles Augustin de Coulomb, in 1785, showed that the force of attraction or repulsion between electrically charged bodies and between magnetic poles also obey an inverse square law like that derived for gravity by Newton. To make the measurements necessary to prove this, Coulomb (independent of John Michell) invented the *torsion balance*.

The mathematical expression for the magnetic force experienced between two magnetic monopoles is given by

$$F_m = \frac{1}{\mu} \frac{p_1 p_2}{r^2}$$

where μ is a constant of proportionality known as the *magnetic permeability*, p_1 and p_2 are the strengths of the two magnetic monopoles, and r is the distance between the two poles. In form, this expression is identical to the gravitational force expression written above. There are, however, two important differences.

- Unlike the gravitational constant, G , the magnetic permeability, μ , is a property of the material in which the two monopoles, p_1 and p_2 , are located. If they are in a vacuum, μ is called the magnetic permeability of free space.
- Unlike m_1 and m_2 , p_1 and p_2 can be either positive or negative in sign. If p_1 and p_2 have the same sign, the force between the two monopoles is repulsive. If p_1 and p_2 have opposite signs, the force between the two monopoles is attractive.

[FAQ](#)
[E-Mail](#)
[Home](#)
[Next](#)
[Last](#)

Forces Associated with Magnetic Monopoles

Given that the magnetic force applied to one magnetic monopole by another magnetic monopole is given by Coulomb's equation, what does the force look like? Assume that there is a negative magnetic pole, $p_1 < 0.0$, located at a point $x=-1$ and $y=0$. Now, let's take a positive magnetic pole, $p_2 > 0.0$, and move it to some location (x,y) and measure the strength and the direction of the magnetic force field.

$$F_m = \frac{1}{\mu} \frac{p_1 p_2}{r^2}$$

We'll plot this force as an arrow in the direction of the force with a length indicating the strength of the force. Repeat this by moving the positive pole to a new location. After doing this at many locations, you will produce a plot similar to the one shown below.

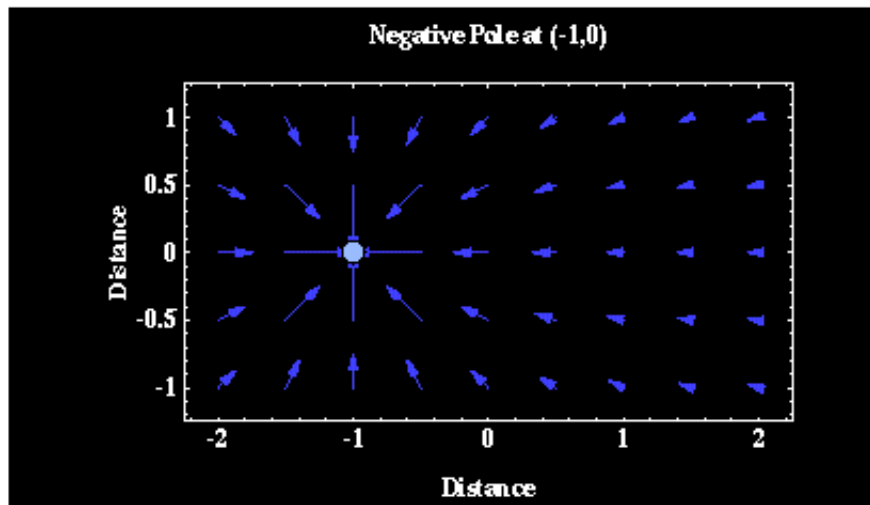

As described by Coulomb's equation, the size of the arrows should decrease as one over the square of the distance between the two magnetic poles* and the direction of the force acting on p_2 is always in the direction toward p_1 (the force is attractive)**.

If instead p_1 is a positive pole located at $x=1$, the plot of the magnetic force acting on p_2 is the same as that shown above except that the force is always directed away from p_1 (the force is repulsive).

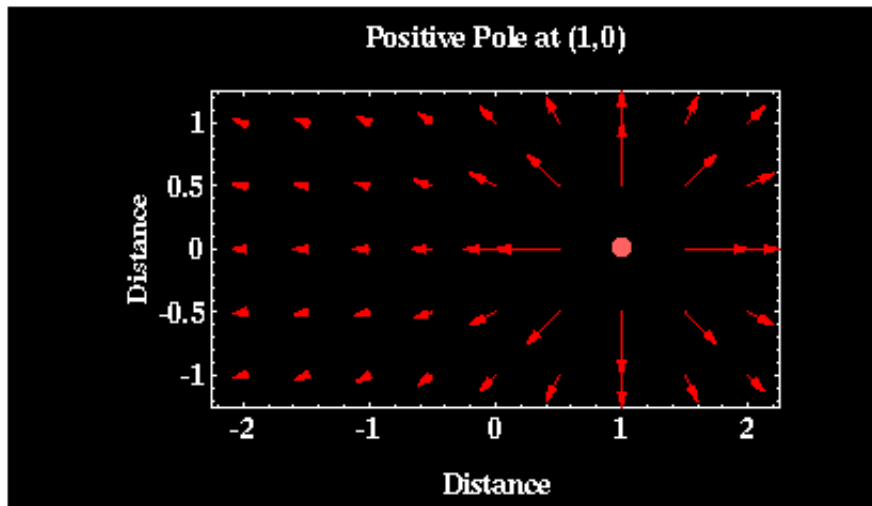

*For plotting purposes, the arrow lengths shown in the figures above decay proportional to one over the distance between the two poles rather than proportional to one over the square of the distance between the two poles. If the true distance relationship were used, the lengths of the arrows would decrease so rapidly with distance that it would be difficult to visualize the distance-force relationship being described.

**If we were to plot the force of gravitational attraction between two point masses, the plot would look identical to this.



Magnetic Dipoles

So far everything seems pretty simple and directly comparable to gravitational forces, albeit with attractive and repulsive forces existing in the magnetic case when only attractive forces existed in the gravitational case. Now things start getting a bit more complicated. The magnetic monopoles that we have been describing have never actually been observed!!

Rather, the fundamental magnetic element appears to consist of two magnetic monopoles, one positive and one negative, separated by some distance. This fundamental magnetic element consisting of two monopoles is called a *magnetic dipole*.

Now let's see what the force looks like from this fundamental magnetic element, the magnetic dipole? Fortunately, we can derive the magnetic force produced by a dipole by considering the force produced by two magnetic monopoles. In fact, this is why we began our discussion on magnetism by looking at magnetic monopoles. If a dipole simply consists of two magnetic monopoles, you might expect that the force generated by a dipole is simply the force generated by one monopole added to the force generated by a second monopole. This is exactly right!!

On the [previous page](#), we plotted the magnetic forces associated with two magnetic monopoles. These are reproduced below on the same figure as the red and purple arrows.

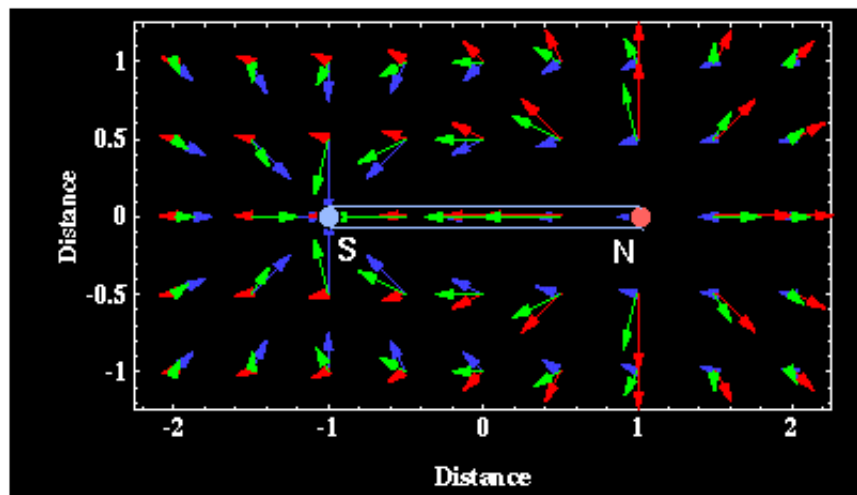

If we add these forces together using *vector addition*, we get the green arrows. These green arrows now indicate the force associated with a magnetic dipole consisting of a negative monopole at $x=-1$, labeled *S*, and a positive monopole at $x=1$, labeled *N*. Shown below are the force arrows for this same magnetic dipole without the red and purple arrows indicating the monopole forces.

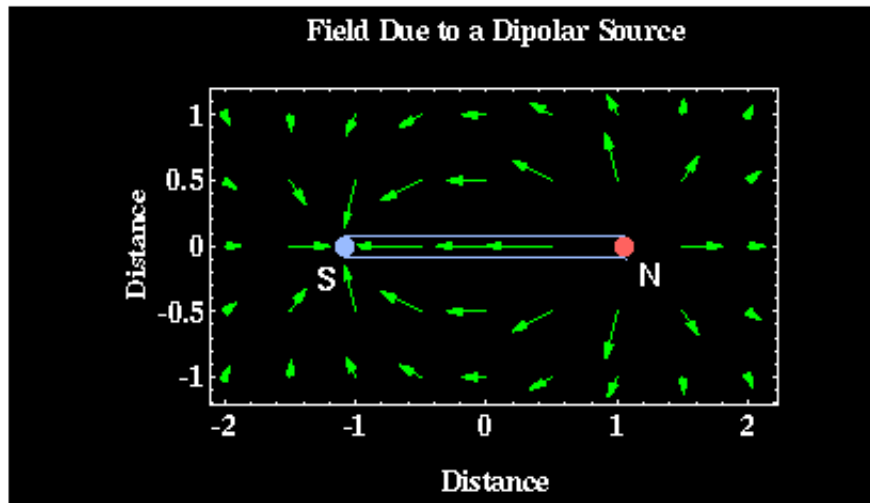

The force associated with this fundamental element of magnetism, the magnetic dipole, now looks more complicated than the simple force associated with gravity. Notice how the arrows describing the magnetic force appear to come out of the monopole labeled N and into the monopole labeled S .

You may recognize this force distribution. It is nothing more than the magnetic force distribution observed around a simple *bar magnet*. In fact, a bar magnet can be thought of as nothing more than two magnetic monopoles separated by the length of the magnet. The magnetic force appears to originate out of the *north pole*, N , of the magnet and to terminate at the *south pole*, S , of the magnet.



Field Lines for a Magnetic Dipole

Another way to visualize the magnetic force field associated with a magnetic dipole is to plot the *field lines* for the force. Field lines are nothing more than a set of lines drawn such that they are everywhere parallel to the direction of the force you are trying to describe, in this case the magnetic force. Shown below is the spatial variation of the magnetic force (green arrows)* associated with a magnetic dipole and a set of field lines (red lines) describing the force.

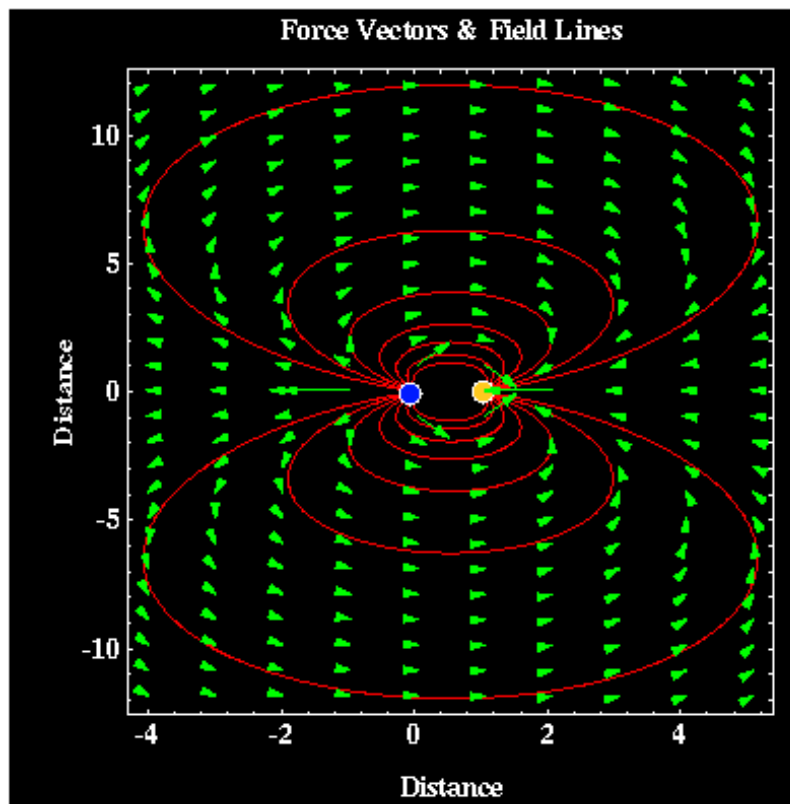

Notice that the red lines representing the field lines are always parallel to the force directions shown by the green arrows. The number and spacing of the red lines that we have chosen to show is arbitrary except for one factor. The position of the red lines shown has been chosen to qualitatively indicate the relative strength of the magnetic field. Where adjacent red lines are closely spaced, such as near the two monopoles (blue and yellow circles) comprising the dipole, the magnetic force is large. The greater the distance between adjacent red lines, the smaller the magnitude of the magnetic force.

*Unlike the force plots shown on the [previous page](#), the arrows representing the force have not been rescaled. Thus, you can now see how rapidly the size of the force decreases with distance from the dipole. Small forces are represented only by an arrow head that is constant in size. In addition, please note that the vertical axis in the above plot covers a distance almost three times as large as the horizontal axis.

[FAQ](#)[E-Mail](#)[Home](#)[Next](#)[Last](#)

Units Associated with Magnetic Poles

$$F_m = \frac{1}{\mu} \frac{p_1 p_2}{r^2}$$

The units associated with magnetic poles and the magnetic field are a bit more obscure than those associated with the [gravitational field](#). From Coulomb's expression, we know that force must be given in Newtons, N , where a Newton is a $kg \cdot m / s^2$. We also know that distance has the units of meters, m . [Permeability](#), μ , is defined to be a unitless constant. The units of pole strength are defined such that if the force, F , is 1 N and the two magnetic poles are separated by 1 m,

each of the poles has a strength of 1 Amp - m (Ampere - meters). In this case, the poles are referred to as *unit poles*.

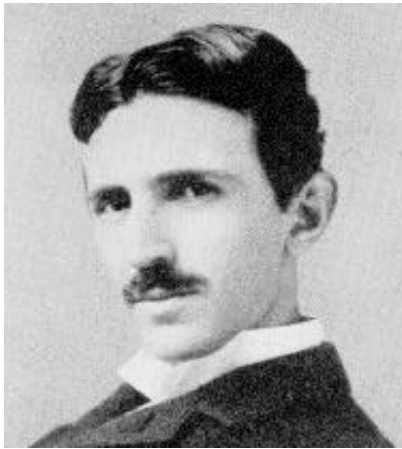

The *magnetic field strength*, H , is defined as the force per unit pole strength exerted by a magnetic monopole, p_1 . H is nothing more than Coulomb's expression divided by p_2 . The magnetic field strength H is the magnetic analog to the gravitational acceleration, g .

$$H = \frac{F_m}{p_2} = \frac{p_1}{\mu r^2}$$

Given the units associated with force, N , and magnetic monopoles, $Amp \cdot m$, the units associated with magnetic field strength are Newtons per Ampere-meter, $N / (Amp \cdot m)$. A $N / (Amp \cdot m)$ is referred to as a *tesla* (T), named after the renowned inventor [Nikola Tesla](#), shown at left.

When describing the magnetic field strength of the earth, it is more common to use units of nanoteslas (nT), where one nanotesla is 1 billionth of a tesla. The average strength of the Earth's magnetic field is about 50,000 nT. A nanotesla is also commonly referred to as a *gamma*.



Magnetic Induction

When a magnetic material, say iron, is placed within a magnetic field, H , the magnetic material will produce its own magnetization. This phenomena is called *induced magnetization*.

In practice, the induced magnetic field (that is, the one produced by the magnetic material) will look like it is being created by a series of magnetic dipoles located within the magnetic material and oriented parallel to the direction of the inducing field, H .

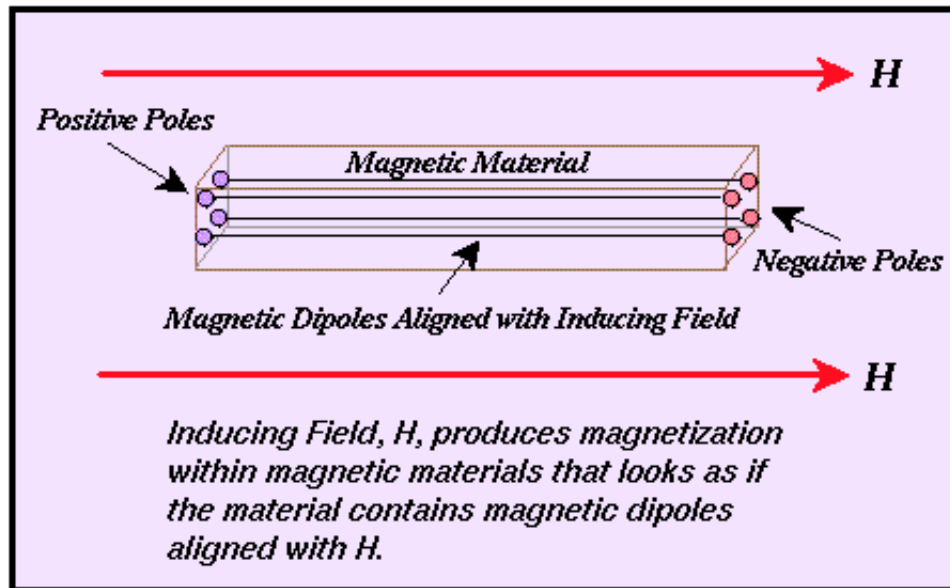

The strength of the magnetic field induced by the magnetic material due to the inducing field is called the *intensity of magnetization, I* .



Magnetic Susceptibility

The intensity of magnetization, I , is related to the strength of the inducing magnetic field, H , through a constant of proportionality, k , known as the magnetic susceptibility.

$$I = k H$$

The magnetic susceptibility is a unitless constant that is determined by the physical properties of the magnetic material. It can take on either positive or negative values. Positive values imply that the induced magnetic field, I , is in the same direction as the inducing field, H . Negative values imply that the induced magnetic field is in the opposite direction as the inducing field.

In magnetic prospecting, the susceptibility is the fundamental material property whose spatial distribution we are attempting to determine. In this sense, magnetic susceptibility is analogous to density in gravity surveying.



Mechanisms for Induced Magnetization

The nature of magnetization material is in general complex, governed by atomic properties, and well beyond the scope of this series of notes. Suffice it to say, there are three types of magnetic materials: paramagnetic, diamagnetic, and ferromagnetic.

- *Diamagnetism* - Discovered by Michael Faraday in 1846. This form of magnetism is a fundamental property of all materials and is caused by the alignment of magnetic moments associated with orbital electrons in the presence of an external magnetic field. For those elements with no unpaired electrons in their outer electron shells, this is the only form of magnetism observed. The susceptibilities of diamagnetic materials are relatively small and negative. Quartz and salt are two common diamagnetic earth materials.
- *Paramagnetism* - This is a form of magnetism associated with elements that have an odd number of electrons in their outer electron shells. Paramagnetism is associated with the alignment of electron spin directions in the presence of an external magnetic field. It can only be observed at relatively low temperatures. The temperature above which paramagnetism is no longer observed is called the *Curie Temperature*. The susceptibilities of paramagnetic substances are small and positive.
- *Ferromagnetism* - This is a special case of paramagnetism in which there is an almost perfect alignment of electron spin directions within large portions of the material referred to as *domains*. Like paramagnetism, ferromagnetism is observed only at temperatures below the Curie temperature. There are three varieties of ferromagnetism.
 - *Pure Ferromagnetism* - The directions of electron spin alignment within each domain are almost all parallel to the direction of the external inducing field. Pure ferromagnetic substances have large (approaching 1) positive susceptibilities. Ferromagnetic minerals do not exist, but iron, cobalt, and nickel are examples of common ferromagnetic elements.

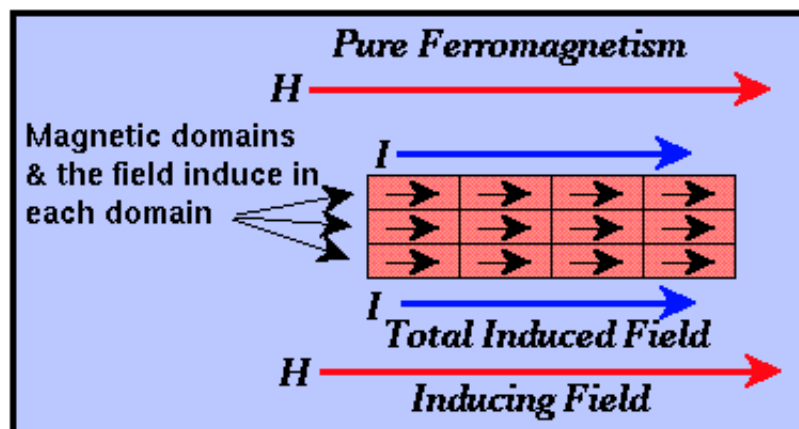

- *Antiferromagnetism* - The directions of electron alignment within adjacent domains are opposite and the relative abundance of domains with each spin direction is approximately equal. The observed magnetic intensity for the material is almost zero. Thus, the susceptibilities of antiferromagnetic materials are almost zero. Hematite is an antiferromagnetic material.

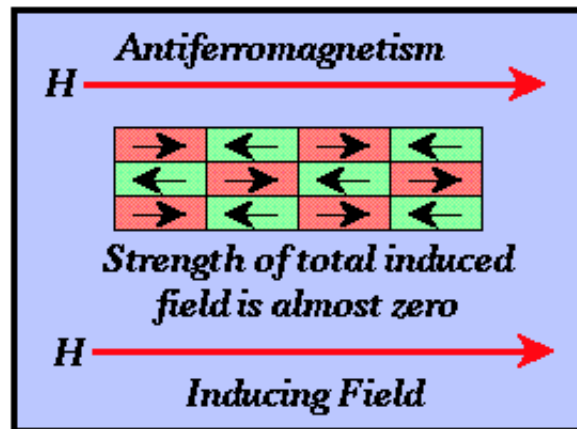

- *Ferromagnetism* - Like antiferromagnetic materials, adjacent domains produce magnetic intensities in opposite directions. The intensities associated with domains polarized in a direction opposite that of the external field, however, are weaker. The observed magnetic intensity for the entire material is in the direction of the inducing field but is much weaker than that observed for pure ferromagnetic materials. Thus, the susceptibilities for ferromagnetic materials are small and positive. The most important magnetic minerals are ferromagnetic and include magnetite, titanomagnetite, ilmenite, and pyrrhotite.

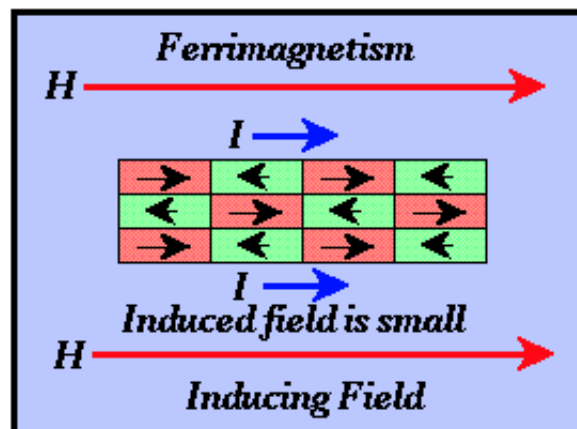

Susceptibilities of Rocks and Minerals

Although the mechanisms by which induced magnetization can arise are rather complex, the field generated by these mechanisms can be quantified by a single, simple parameter known as the susceptibility, k . As we will show below, the determination of a material type through a knowledge of its susceptibility is an extremely difficult proposition, even more so than by determining a material type through a knowledge of its [density](#).

The susceptibilities of various rocks and minerals are shown below.

Material	Susceptibility $\times 10^3$ (SI)*
Air	~0
Quartz	-0.01
Rock Salt	-0.01
Calcite	-0.001 - 0.01
Sphalerite	0.4
Pyrite	0.05 - 5
Hematite	0.5 - 35
Illmenite	300 - 3500
Magnetite	1200 - 19,200
Limestones	0 - 3
Sandstones	0 - 20
Shales	0.01 - 15
Schist	0.3 - 3
Gneiss	0.1 - 25
Slate	0 - 35
Granite	0 - 50
Gabbro	1 - 90
Basalt	0.2 - 175
Peridotite	90 - 200

Unlike [density](#), notice the large range of susceptibilities not only between varying rocks and minerals but also within rocks of the same type. It is not uncommon to see variations in susceptibility of several orders of magnitude for different igneous rock samples. In addition, like density, there is considerable overlap in the measured susceptibilities. Hence, a knowledge of susceptibility alone will not be sufficient to determine rock type, and, alternately, a knowledge of rock type is often not sufficient to estimate the expected susceptibility.

This wide range in susceptibilities implies that spatial variations in the observed magnetic field may be readily related to geologic structure. Because variations within any given rock type are also large, however, it will be

difficult to construct corrections to our observed magnetic field on assumed susceptibilities as was done in constructing some of the fundamental gravitational corrections ([Bouguer slab correction](#) and [Topographic corrections](#)).

*Although susceptibility is unitless, its values differ depending on the unit system used to quantify H and I . The values given here assume the use of the *SI*, International System of Units (Système International d'Unités) based on the meter, kilogram, and second. Another unit system, the *cgs*, centimeter, gram, and second system is also commonly used. To convert the SI units for susceptibility given above to *cgs*, divide by $4\pi \times 10^{-7}$.



Remanent Magnetization

So, as we've seen, if we have a magnetic material and place it in an external magnetic field (one that we've called the inducing field), we can make the magnetic material produce its own magnetic field. If we were to measure the total magnetic field near the material, that field would be the sum of the external, or inducing field, and the induced field produced in the material. By measuring spatial variations in the total magnetic field and by knowing what the inducing field looks like, we can, in principle, map spatial variations in the induced field and from this determine spatial variations in the magnetic susceptibility of the subsurface.

Although this situation is a bit more complex than the gravitational situation, it's still manageable. There is, however, one more complication in nature concerning material magnetism that we need to consider. In the scenario we've been discussing, the induced magnetic field is a direct consequence of a magnetic material being surrounded by an inducing magnetic field. If you turn off the inducing magnetic field, the induced magnetization disappears. Or does it?

If the magnetic material has relatively large susceptibilities, or if the inducing field is strong, the magnetic material will retain a portion of its induced magnetization even after the inducing field disappears. This remaining magnetization is called *Remanent Magnetization*.

Remanent Magnetization is the component of the material's magnetization that solid-earth geophysicists use to map the motion of continents and ocean basins resulting from plate tectonics. Rocks can acquire a remanent magnetization through a variety of processes that we don't need to discuss in detail. A simple example, however, will illustrate the concept. As a volcanic rock cools, its temperature decreases past the Curie Temperature. At the Curie Temperature, the rock, being magnetic, begins to produce an induced magnetic field. In this case, the inducing field is the Earth's magnetic field. As the Earth's magnetic field changes with time, a portion of the induced field in the rock does not change but remains fixed in a direction and strength reflective of the Earth's magnetic field at the time the rock cooled through its Curie Temperature. This is the remanent magnetization of the rock--the recorded magnetic field of the Earth at the time the rock cooled past its Curie Temperature.

The only way you can measure the remanent magnetic component of a rock is to take a sample of the rock back to the laboratory for analysis. This is time consuming and expensive. As a result, in exploration geophysics, we typically assume there is *no* remanent magnetic component in the observed magnetic field. Clearly, however, this assumption is wrong and could possibly bias our interpretations.



Magnetic Field Nomenclature

As you can see, although we started by comparing the magnetic field to the gravitational field, the specifics of magnetism are far more complex than gravitation. Despite this, it is still useful to start from the intuition you have gained through your study of gravitation when trying to understand magnetism. Before continuing, however, we need to define some of the relevant terms we will use to describe the Earth's magnetic field.

When discussing gravity, we really didn't talk much about how we describe gravitational acceleration. To some extent, this is because such a description is almost obvious; gravitational acceleration has some size (measured in geophysics with a [gravimeter](#) in [mgals](#)), and it is always acting downward (in fact, it is how we define down). Because the magnetic field does not act along any such easily definable direction, earth scientists have developed a nomenclature to describe the magnetic field at any point on the Earth's surface.

At any point on the Earth's surface, the magnetic field, F^* , has some strength and points in some direction. The following terms are used to describe the direction of the magnetic field.

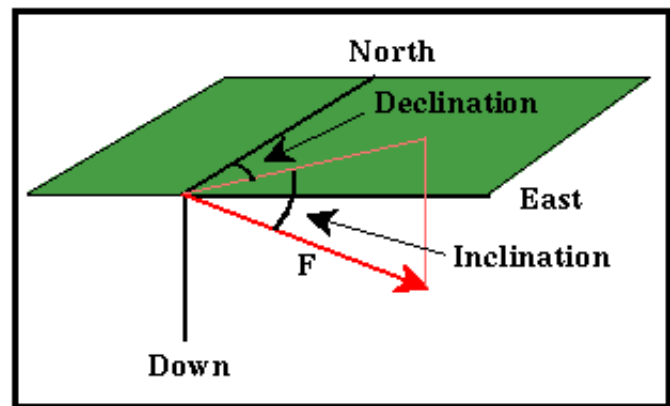

- *Declination* - The angle between north and the horizontal projection of F . This value is measured positive through east and varies from 0 to 360 degrees.
- *Inclination* - The angle between the surface of the earth and F . Positive inclinations indicate F is pointed downward, negative inclinations indicate F is pointed upward. Inclination varies from -90 to 90 degrees.
- *Magnetic Equator* - The location around the surface of the Earth where the Earth's magnetic field has an inclination of zero (the magnetic field vector F is horizontal). This location *does not* correspond to the Earth's rotational equator.
- *Magnetic Poles* - The locations on the surface of the Earth where the Earth's magnetic field has an inclination of either plus or minus 90 degrees (the magnetic field vector F is vertical). These locations *do not* correspond to the Earth's north and south poles.

*In this context, and throughout the remainder of these notes, F includes contributions from the Earth's main** magnetic field (the inducing field), induced magnetization from crustal sources, and any contributions from sources external to the Earth.

**The *main* magnetic field refers to that portion of the Earth's magnetic field that is believed to be generated within the Earth's core. It constitutes the largest portion of the magnetic field and is the field that acts to induce magnetization in crustal rocks that we are interested in for exploration applications.

[FAQ](#)
[E-Mail](#)
[Home](#)
[Next](#)
[Last](#)

The Earth's Magnetic Field

Ninety percent of the Earth's magnetic field looks like a magnetic field that would be generated from a [dipolar magnetic source](#) located at the center of the Earth and aligned with the Earth's rotational axis. This [first order](#) description of the Earth's magnetic field was first given by Sir William Gilbert in 1600. The strength of the magnetic field at the poles is about 60,000 nT. If this dipolar description of the field were complete, then the magnetic equator would correspond to the Earth's equator and the magnetic poles would correspond to the geographic poles. Alas, as we've come to expect from magnetism, such a simple description is not sufficient for analysis of the Earth's magnetic field.

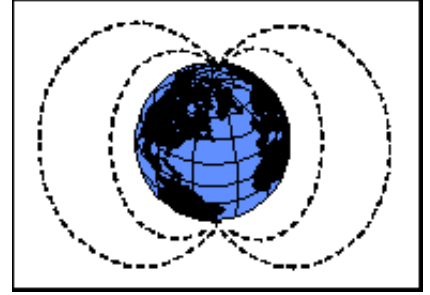

The remaining 10% of the magnetic field can not be explained in terms of simple dipolar sources. [Complex models](#) of the Earth's magnetic field have been developed and are [available](#). Shown below is a sample of one of these models generated by the USGS. The plot shows a map of [declinations](#) for a model of the magnetic field as it appeared in the year 1995*.

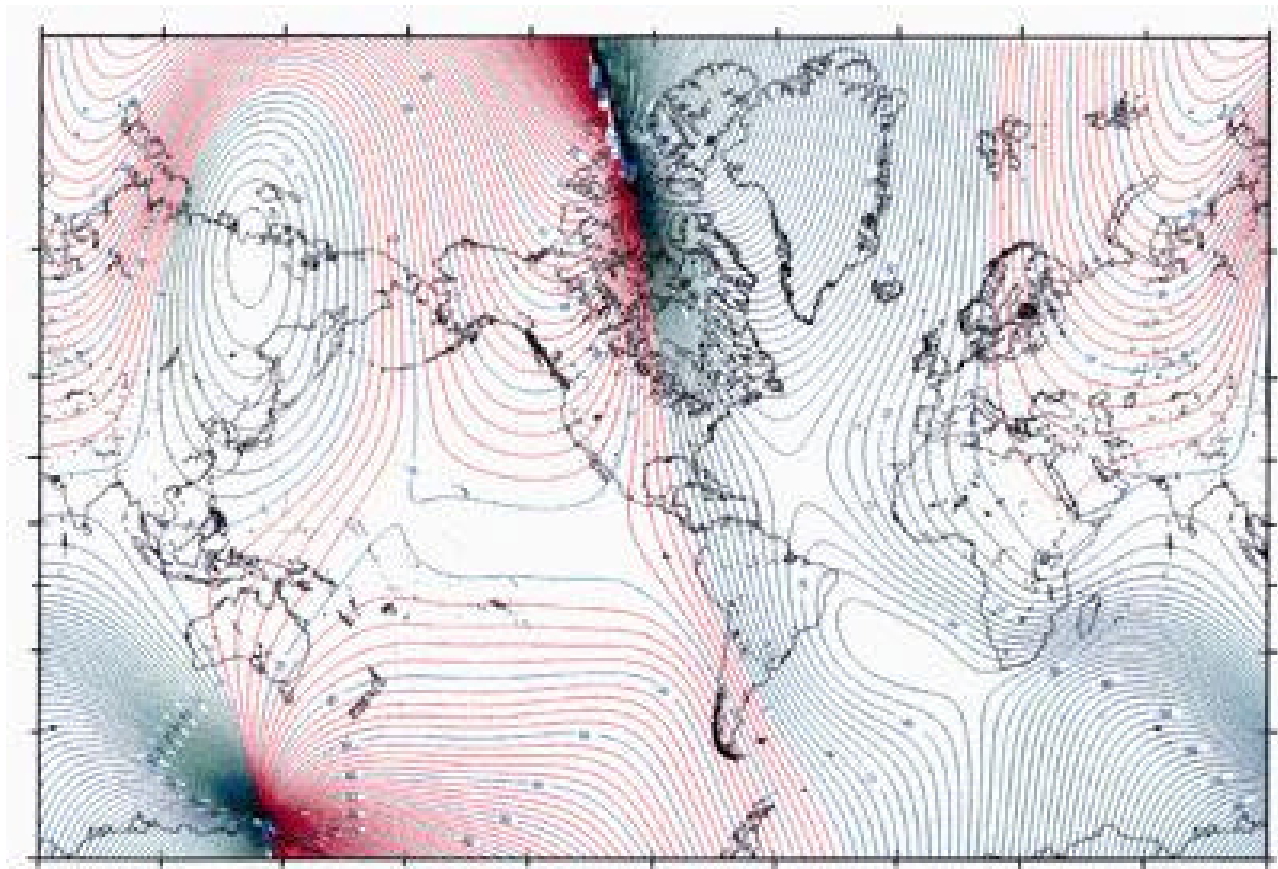

If the Earth's field were simply dipolar with the axis of the dipole oriented along the Earth's rotational axis, all declinations would be 0 degrees (the field would always point toward the north). As can be seen, the observed declinations are quite complex.

As observed on the surface of the earth, the magnetic field can be broken into three separate components.

- *Main Field* - This is the largest component of the magnetic field and is believed to be caused by electrical currents in the Earth's fluid outer core. For exploration work, this field acts as the [inducing](#) magnetic field.
- *External Magnetic Field* - This is a relatively small portion of the observed magnetic field that is generated from magnetic sources external to the earth. This field is believed to be produced by interactions of the Earth's ionosphere with the solar wind. Hence, [temporal variations](#) associated with the external magnetic field are correlated to solar activity.
- *Crustal Field* - This is the portion of the magnetic field associated with the magnetism of crustal rocks. This portion of the field contains both magnetism caused by induction from the Earth's main magnetic field and from [remanent](#) magnetization.

The figure shown above was constructed to emphasize characteristics of the main magnetic field. Although this portion of the field is in itself complex, it is understood quite well. Models of the main field are available and can be used for data reduction.

*As we'll describe later, another potential complication in using magnetic observations is that the Earth's magnetic field changes with time!



Magnetics and Geology - A Simple Example

This is all beginning to get a bit complicated. What are we actually going to observe, and how is this related to geology? The portion of the magnetic field that we have described as the main magnetic field is believed to be generated in the Earth's core. There are a variety of reasons why geophysicists believe that the main field is being generated in the Earth's core, but these are not important for our discussion. In addition to these core sources of magnetism, rocks exist near the Earth's surface that are below their Curie temperature and as such can exhibit induced as well as remanent magnetization*.

Therefore, if we were to measure the magnetic field along the surface of the earth, we would record magnetization due to both the main and induced fields. The induced field is the one of interest to us because it relates to the existence of rocks of high or low magnetic susceptibility near our instrument. If our measurements are taken near rocks of high magnetic susceptibility, we will, in general**, record magnetic field strengths that are larger than if our measurements were taken at a great distance from rocks of high magnetic susceptibility. Hence, like gravity, we can potentially locate subsurface rocks having high magnetic susceptibilities by mapping variations in the strength of the magnetic field at the Earth's surface.

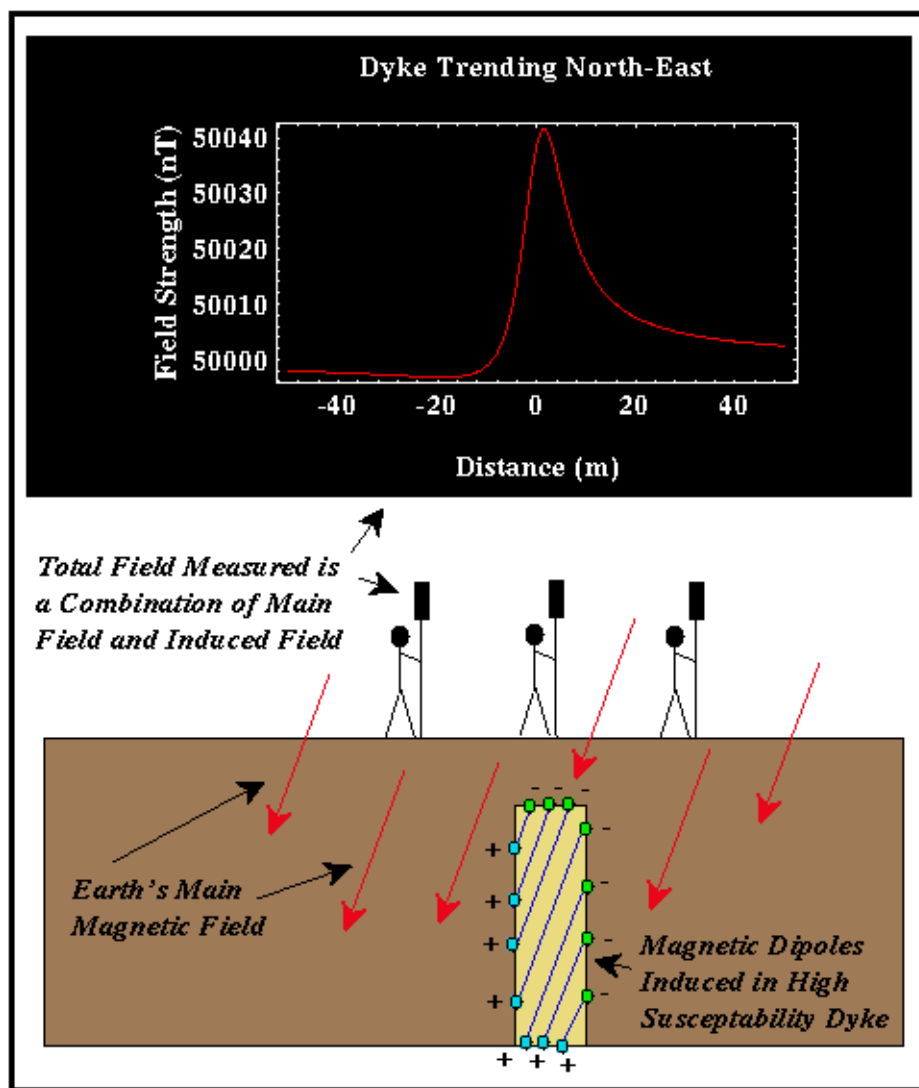

Consider the example shown above. Suppose we have a buried dyke with a susceptibility of 0.001 surrounded by sedimentary rocks with no magnetic susceptibility. The dyke in this example is 3 meters wide, is buried 5 meters deep, and trends to the northeast. To find the dyke, we could measure the strength of the magnetic field (in this case along an east-west

trending line). As we approach the dyke, we would begin to observe the induced magnetic field associated with the dyke in addition to the Earth's main field. Thus, we could determine the location of the dyke and possibly its dimensions by measuring the spatial variation in the strength of the magnetic field.

There are several things to notice about the magnetic anomaly produced by this dyke.

- Like a gravitational [anomaly](#) associated with a high-density body, the magnetic anomaly associated with the dyke is localized to the region near the dyke. The size of the anomaly rapidly decays with distance away from the dyke.
- Unlike the gravity anomaly we would expect from a higher-density dyke, the magnetic anomaly is not symmetric about the dyke's midpoint which is at a distance of zero in the above example. Not only is the anomaly shaped differently to the left and to the right of the dyke, but the maximum anomaly is *not* centered at the center of the dyke. These observations are in general true for all magnetic anomalies. The specifics of this generalization, however, will depend on the shape and orientation of the magnetized body, its location (bodies of the same shape and size will produce different anomalies when located at different places), and the direction in which the profile is taken.
- The size of the anomaly produced by this example is about 40 nT. This is a pretty good- sized anomaly. It is not uncommon to look for anomalies as small as a few nT. Thus, we must develop surveying techniques to reduce systematic and random errors to smaller than a few nT.

*We will assume that there is no remanent magnetization throughout the remainder of this discussion.

**Unlike gravity, magnetic anomalies are rather complex in shape and making sweeping statements like this can be very dangerous.

[FAQ](#)[E-Mail](#)[Home](#)[Next](#)[Last](#)

Temporal Variations of the Earth's Magnetic Field - Overview

Like the [gravitational field](#), the magnetic field varies with time. When describing temporal variations of the magnetic field, it is useful to classify these variations into one of three types depending on their rate of occurrence and source. Please note explicitly that the temporal variations in the magnetic field that we will be discussing are those that have been observed directly during human history. As such, the most well-known temporal variation, magnetic polarity reversals, while important in the study of earth history, will not be considered in this discussion. We will, however, consider the following three temporal variations:

- *Secular Variations* - These are long-term (changes in the field that occur over years) variations in the [main magnetic field](#) that are presumably caused by fluid motion in the Earth's Outer Core. Because these variations occur slowly with respect to the time of completion of a typical exploration magnetic survey, these variations will not complicate data reduction efforts.
- *Diurnal Variations* - These are variations in the magnetic field that occur over the course of a day and are related to variations in the Earth's [external magnetic field](#). This variation can be on the order of 20 to 30 nT per day and should be accounted for when conducting exploration magnetic surveys.
- *Magnetic Storms* - Occasionally, magnetic activity in the ionosphere will abruptly increase. The occurrence of such storms correlates with enhanced sunspot activity. The magnetic field observed during such times is highly irregular and unpredictable, having amplitudes as large as 1000 nT. Exploration magnetic surveys should not be conducted during magnetic storms.

*In this context, rapidly means on the order of hundreds to tens of years, down to minutes.

[FAQ](#)[E-Mail](#)[Home](#)[Next](#)[Last](#)

Secular Variations of the Earth's Magnetic Field

The fact that the Earth's magnetic field varies with time was well established several centuries ago. In fact, this is the primary reason that permanent magnetic observatories were established from which we have learned how the magnetic field has changed over the past few centuries. Many [sources](#) of historical information are available.

Shown below is a plot of the declination and inclination of the magnetic field around Britain from the years 1500 through 1900.

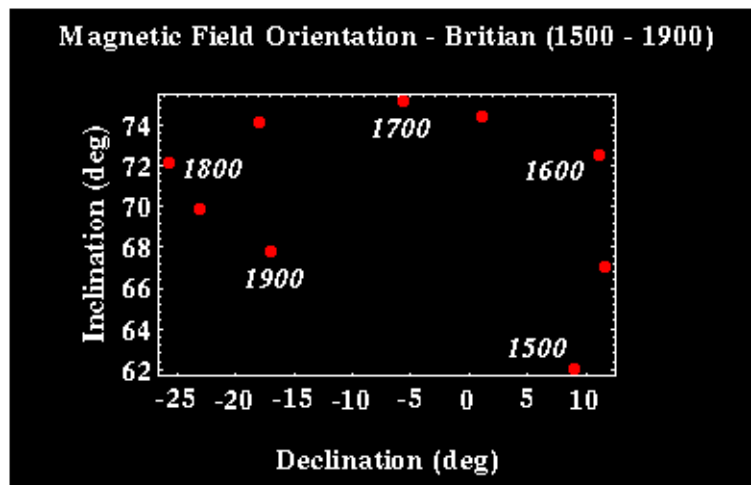

At this one location, you can see that over the past 400 years, the declination has varied by almost 37 degrees while the inclination has varied by as much as 13 degrees. These changes are generally assumed to be associated with the Earth's main magnetic field. That is, these are changes associated with that portion of the magnetic field believed to be generated in the Earth's core. As such, solid earth geophysicists are very interested in studying these secular variations, because they can be used to understand the dynamics of the Earth's core.

To understand these temporal variations and to quantify the rate of variability over time, standard reference models are constructed from magnetic observatory observations about every five years. One commonly used set of reference models is known as the [International Geomagnetic Reference Field](#). Based on these models, it is possible to [predict](#) the portion of the observed magnetic field associated with the Earth's main magnetic field at any point on the Earth's surface, both now and for several decades in the past.

Because the main magnetic field as described by these secular variations changes slowly with respect to the time it takes us to complete our exploration magnetic survey, this type of temporal variation is of little importance to us.

[FAQ](#)[E-Mail](#)[Home](#)[Next](#)[Last](#)

Diurnal Variations of the Earth's Magnetic Field

Of more importance to exploration geophysical surveys are the daily, or diurnal, variations of the Earth's magnetic field. These variations were first discovered in 1722 in England when it was also noted that these daily variations were larger in summer than in winter.

The plot below shows typical variations in the magnetic data recorded at a single location (Boulder, Colorado) over a time period of two days. Although there are high-frequency components to this variation, notice that the dominant trend is a slowly varying component with a [period](#) of about 24 hours. In this location, at this time, the amplitude of this daily variation is about 20 nT.

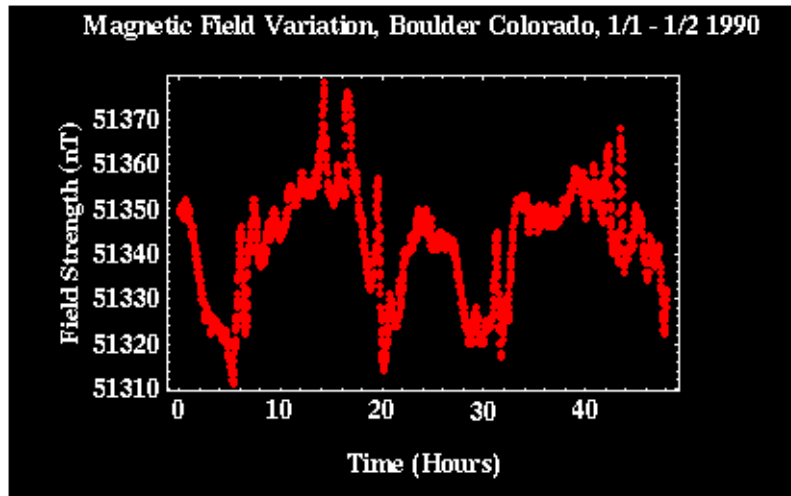

These variations are believed to be caused by electric currents induced in the Earth from an external source. In this case, the external source is believed to be electric currents in the upper atmosphere, or the ionosphere. These electric currents in the ionosphere are in turn driven by solar activity.

Given the size of these variations, the size of the [magnetic anomalies](#) we would expect in a typical geophysical survey, and the fact that surveys could take several days or weeks to complete, it is clear that we must account for diurnal variations when interpreting our magnetic data.

[FAQ](#)[E-Mail](#)[Home](#)[Next](#)[Last](#)

Magnetic Storms

In addition to the relatively predictable and smoothly varying [diurnal](#) variations, there can be transient, large amplitude (up to 1000 nT) variations in the field that are referred to as *Magnetic storms*. The frequency of these storms correlates with sunspot activity. Based on this, some [prediction](#) of magnetic storm activity is possible. The most intense storms can be observed globally and may last for several days.

The figure to the right shows the magnetic field recorded at a single location during such a transient event. Although the magnetic storm associated with this event is not particularly long-lived, notice that the size of the magnetic field during this event varies by almost 100 nT in a time period shorter than 10 minutes!!

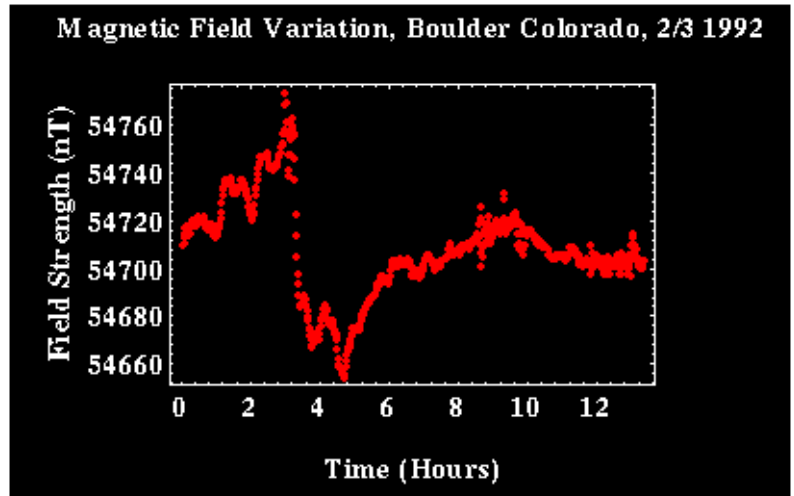

Exploration magnetic surveys should *not* be conducted during times of magnetic storms. This is simply because the variations in the field that they can produce are large, rapid, and spatially varying. Therefore, it is difficult to correct for them in acquired data.

[FAQ](#)[E-Mail](#)[Home](#)[Next](#)[Last](#)

Measuring the Earth's Magnetic Field

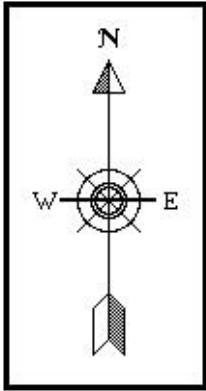

Instruments for measuring aspects of the Earth's magnetic field are among some of the oldest scientific instruments in existence. Magnetic instruments can be classified into two types.

- *Mechanical Instruments* - These are instruments that are mechanical in nature that usually measure the attitude (its direction or a component of its direction) of the magnetic field. The most common example of this type of instrument is the simple compass. The compass consists of nothing more than a small test magnet that is free to rotate in the horizontal plane. Because the positive pole of the test magnet is attracted to the Earth's negative magnetic pole and the negative pole of the test magnet is attracted to the Earth's positive magnetic pole, the test magnet will align itself along the horizontal direction of the Earth's magnetic field. Thus, it provides measurements of the [declination](#) of the magnetic field. The earliest known compass was invented by the Chinese no later than the first century A.D., and more likely as early as the second century B.C.

Although compasses are the most common type of mechanical device used to measure the horizontal attitude of the magnetic field, other devices have been devised to measure other components of the magnetic field. Most common among these are the *dip needle* and the *torsion magnetometer*. The dip needle, as its name implies, is used to measure the [inclination](#) of the magnetic field. The torsion magnetometer is a device that can measure, through mechanical means, the strength of the vertical component of the magnetic field.

- *Magnetometers* - Magnetometers are instruments, usually operating non-mechanically, that are capable of measuring the strength, or a component of the strength, of the magnetic field. The first advances in designing these instruments were made during WWII when [Fluxgate Magnetometers](#) were developed for use in submarine detection.

Since that time, several other magnetometer designs have been developed that include the [Proton Precession](#) and Alkali-Vapor magnetometers.

In the following discussion, we will describe only the fluxgate and the proton precession magnetometers, because they are the most commonly used magnetometers in exploration surveys.

[FAQ](#)[E-Mail](#)[Home](#)[Next](#)[Last](#)

Fluxgate Magnetometer

The fluxgate magnetometer was originally designed and developed during World War II. It was built for use as a submarine detection device for low-flying aircraft. Today it is used for conducting magnetic surveys from aircraft and for making borehole measurements. A schematic of the fluxgate magnetometer is shown below.

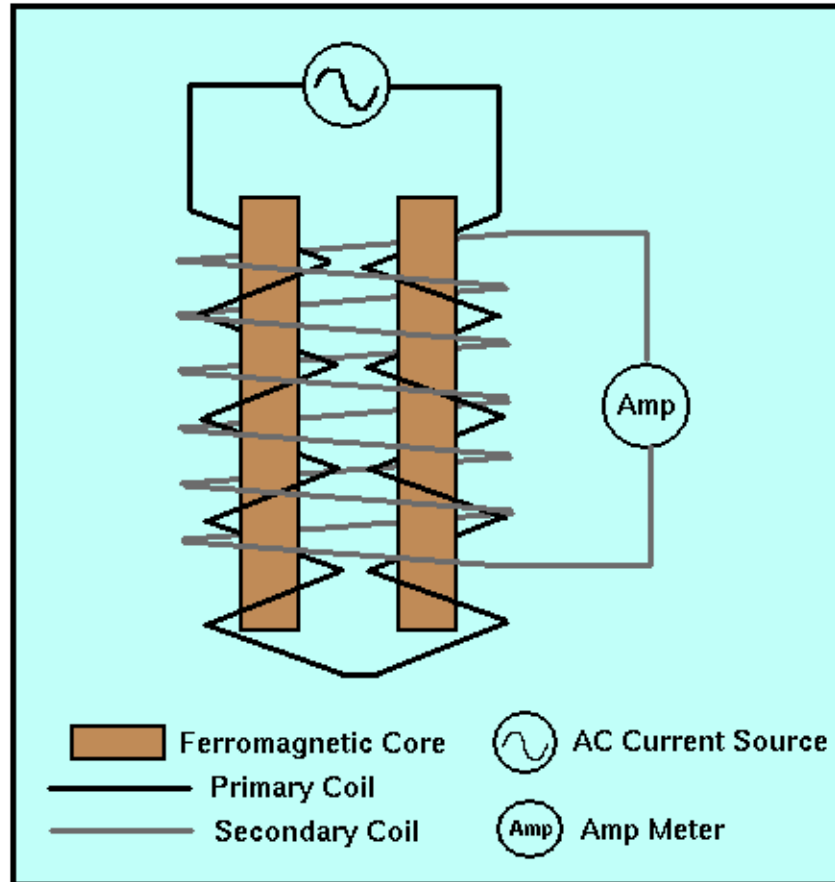

The fluxgate magnetometer is based on what is referred to as the *magnetic saturation circuit*. Two parallel bars of a **ferromagnetic** material are placed closely together. The **susceptibility** of the two bars is large enough so that even the Earth's relatively weak magnetic field can produce magnetic saturation* in the bars.

Each bar is wound with a primary coil, but the direction in which the coil is wrapped around the bars is reversed. An alternating current (AC) is passed through the primary coils causing a large, inducing magnetic field that produces induced magnetic fields in the two cores that have the same strengths but opposite orientations.

A secondary coil surrounds the two ferromagnetic cores and the primary coil. The magnetic fields induced in the cores by the primary coil produce a voltage potential in the secondary coil. In the absence of an external field (i.e., if the earth had no magnetic field), the voltage detected in the secondary coil would be zero because the magnetic fields generated in the two cores have the same strength but are in opposite directions (their affects on the secondary coil exactly cancel).

If the cores are aligned parallel to a component of a weak, external magnetic field, one core will produce a magnetic field in the same direction as the external field and reinforce it. The other will be in opposition to the field and produce an induced field that is smaller. This difference is sufficient to induce a measureable voltage in the secondary coil that is proportional to the strength of the magnetic field in the direction of the cores.

Thus, the fluxgate magnetometer is capable of measuring the strength of any component of the Earth's magnetic field by simply re-orienting the instrument so that the cores are parallel to the desired component. Fluxgate magnetometers are capable of measuring the strength of the magnetic field to about 0.5 to 1.0 nT. These are relatively simple instruments to construct, hence they are relatively inexpensive (\$5,000 - \$10,000). Unlike the commonly used [gravimeters](#), fluxgate magnetometers show no appreciable instrument [drift](#) with time.

*Magnetic saturation refers to the induced magnetic field produced in the bars. In general, as the magnitude of the inducing field increases, the magnitude of the induced field increases in the same proportion as given by our [mathematical expression](#) relating the external to the induced magnetic fields. For large external field strengths, however, this simple relationship between the inducing and the induced field no longer holds. Saturation occurs when increases in the strength of the inducing field no longer produce larger induced fields.

[FAQ](#)[E-Mail](#)[Home](#)[Next](#)[Last](#)

Proton Precession Magnetometer

For land-based magnetic surveys, the most commonly used magnetometer is the proton precession magnetometer. Unlike the [fluxgate](#) magnetometer, the proton precession magnetometer only measures the total size of the Earth's magnetic field. These types of measurements are usually referred to as *total field* measurements. A schematic of the proton precession magnetometer is shown below.

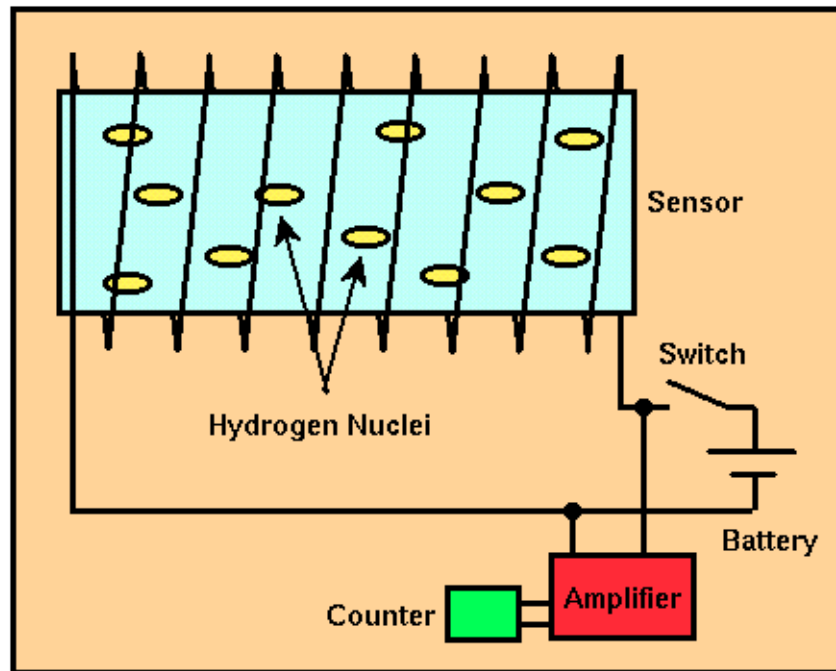

The sensor component of the proton precession magnetometer is a cylindrical container filled with a liquid rich in hydrogen atoms surrounded by a coil. Commonly used liquids include water, kerosene, and alcohol. The sensor is connected by a cable to a small unit in which is housed a power supply, an electronic switch, an amplifier, and a frequency counter.

When the switch is closed, a DC current delivered by a battery is directed through the coil, producing a relatively strong magnetic field in the fluid-filled cylinder. The hydrogen nuclei (protons), which behave like minute spinning dipole magnets, become aligned along the direction of the applied field (i.e., along the axis of the cylinder). Power is then cut to the coil by opening the switch. Because the Earth's magnetic field generates a torque on the aligned, spinning hydrogen nuclei, they begin to precess* around the direction of the Earth's total field. This precession induces a small alternating current in the coil. The frequency of the AC current is equal to the frequency of precession of the nuclei. Because the frequency of precession is proportional to the strength of the total field and because the constant of proportionality is well known, the total field strength can be determined quite accurately.

Like the fluxgate magnetometer, the proton precession magnetometer is relatively easy to construct. Thus, it is also relatively inexpensive (\$5,000 - \$10,000). The strength of the total field can be measured down to about 0.1 nT. Like fluxgate magnetometers, proton precession magnetometers show no appreciable instrument [drift](#) with time.

One of the important advantages of the proton precession magnetometer is its ease of use and reliability. Sensor orientation need only be set to a high angle with respect to the Earth's magnetic field. No precise leveling or orientation is needed. If, however, the magnetic field changes rapidly from place to place (larger than about 600 nT/m), different portions of the cylindrical sensor will be influenced by magnetic fields of various magnitudes, and readings will be seriously degraded. Finally, because the signal generated by precession is small, this instrument can not be used near AC power sources.

*Precession is motion like that experienced by a top as it spins. Because of the Earth's gravitational field, a spinning top not only spins about its axis of rotation, but the axis of rotation rotates about vertical. This rotation of the top's spin axis is referred to as precession.

[FAQ](#)[E-Mail](#)[Home](#)[Next](#)[Last](#)

Total Field Measurements

Given the ease of use of the [proton precession](#) magnetometer, most exploration geophysical surveys employ this instrument and thus measure only the magnitude of the total magnetic field as a function of position. Surveys conducted using the proton precession magnetometer do not have the ability to determine the direction of the total field as a function of location.

Ignoring for the moment the temporally varying contribution to the recorded magnetic field caused by the [external magnetic field](#), the magnetic field we record with our proton precession magnetometer has two components:

- The [main](#) magnetic field, or that part of the Earth's magnetic field generated by deep (outer core) sources. The direction and size of this component of the magnetic field at some point on the Earth's surface is represented by the vector labeled F_e in the figure.
- The [anomalous](#) magnetic field, or that part of the Earth's magnetic field caused by magnetic induction of crustal rocks or remanent magnetization of crustal rocks. The direction and size of this component of the magnetic field is represented by the vector labeled F_a in the figure.

The total magnetic field we record, labeled F_t in the figure, is nothing more than the sum of F_e and F_a .

Typically, F_e is much larger than F_a , as is shown in the figure (50,000 nT versus 100 nT). If F_e is much larger than F_a , then F_t will point almost in the same direction as F_e regardless of the direction of F_a . That is because the anomalous field, F_a , is so much smaller than the main field, F_e , that the total field, F_t , will be almost parallel to the main field.

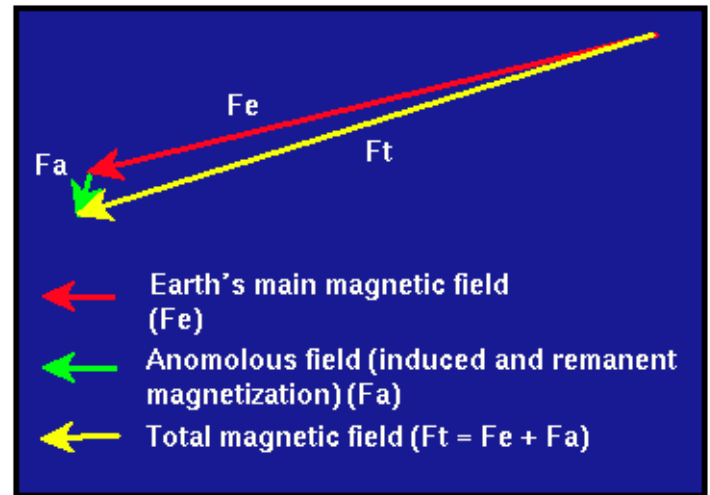
[FAQ](#)
[E-Mail](#)
[Home](#)
[Next](#)
[Last](#)

Modes of Acquiring Magnetic Observations

Magnetic observations are routinely collected using any one of three different field operational strategies.

- *Airborne* - Both fluxgate and proton precession magnetometers can be mounted within or towed behind aircraft, including helicopters. These so-called *aeromagnetic surveys* are rapid and cost effective. When relatively large areas are involved, the cost of acquiring 1 km of data from an aeromagnetic survey is about 40% less than the cost of acquiring the same data on the ground. In addition, data can be obtained from areas that are otherwise inaccessible. Among the most difficult problems associated with aeromagnetic surveys is fixing the position of the aircraft at any time. With the development of realtime, differential [GPS](#) systems, however, this difficulty is rapidly disappearing.
- *Shipborne* - Magnetic surveys can also be completed over water by towing a magnetometer behind a ship. Obviously, marine magnetic surveying is slower than airborne surveying. When other geophysical methods are being conducted by ship, however, it may make sense to acquire magnetic data simultaneously.
- *Ground Based* - Like gravity surveys, magnetic surveys are also commonly conducted on foot or with a vehicle. Ground-based surveys may be necessary when the target of interest requires more closely-spaced readings than are possible to acquire from the air. In the next discussion we will concentrate on ground-based surveys. All of this discussion, however, could be applied to air- and shipborne surveys also.

Because magnetic surveying is generally far cheaper than other geophysical methods, magnetic observations are commonly used for reconnaissance. These surveys can cover large areas and are used to identify the locations of targets for more detailed investigations. Because of their cost effectiveness, magnetic surveys usually consist of areal distributions of data instead of single lines of data. We will refer to the collection of geophysical observations over a geographic area as *two-dimensional surveys*. Data that is collected along a single line of observations will be referred to as *one-dimensional surveys*.

[FAQ](#)[E-Mail](#)[Home](#)[Next](#)[Last](#)

Magnetic Cleanliness and Interference

* When making total field measurements from which estimates of the subsurface distribution of magnetic susceptibility or the presence of subsurface magnetized bodies are made, it is imperative that factors affecting the recorded field other than these be eliminated or isolated so that they can be removed. We have already discussed several of these added complications, including spatial variations of the Earth's [main magnetic field](#) and [temporal](#) variations mostly associated with the [external magnetic field](#). In addition to these factors which we can not control, there are other sources of *noise* that we can control.

Because any ferromagnetic substance can produce an induced magnetic field in the presence of the Earth's main field and because modern magnetometers are very sensitive (0.1 nT), the field crew running the magnetic survey must divest itself of all ferrous objects. This includes, but is not limited to, belt buckles, knives, wire-rimmed glasses, etc. As a result of this, proton precession magnetometers are typically placed on two to three meter poles to remove them from potential noise sources worn by the operators.

In addition to noise sources carried by the operators, many sources of magnetic noise may be found in the environment. These can include any ferrous objects such as houses, fences, railroad rails, cars, rebar in concrete foundations, etc. Finally, when using a proton precession magnetometer, reliable readings will be difficult to obtain near sources of AC power such as utility lines and transformers.



*Figure from *Introduction to Geophysical Prospecting*, M. Dobrin and C. Savit

[FAQ](#)[E-Mail](#)[Home](#)[Next](#)[Last](#)

Strategies for Dealing with Temporal Variations

Like our [gravity observations](#), [magnetic readings](#) taken at the same location at different times will not yield the same results. There are temporal variations in both the Earth's magnetic and gravitational fields.

In [acquiring gravity observations](#), we accounted for this temporal variability by periodically reoccupying a base station and using the variations in this reading to account for instrument drift and temporal variations of the field. We could use the same strategy in acquiring magnetic observations but is not routinely done for the following reasons:

- *Field variations can be more erratic* - Unlike the gravitational field, the magnetic field can vary quite erratically with time, as shown in the figures below. What this means is that to adequately approximate the temporal variation in the magnetic field by [linearly interpolating](#) between base station reoccupations, a very short reoccupation time interval may be required. The shorter the reoccupation interval, the more time is spent at the base station and the longer the survey will take to complete.

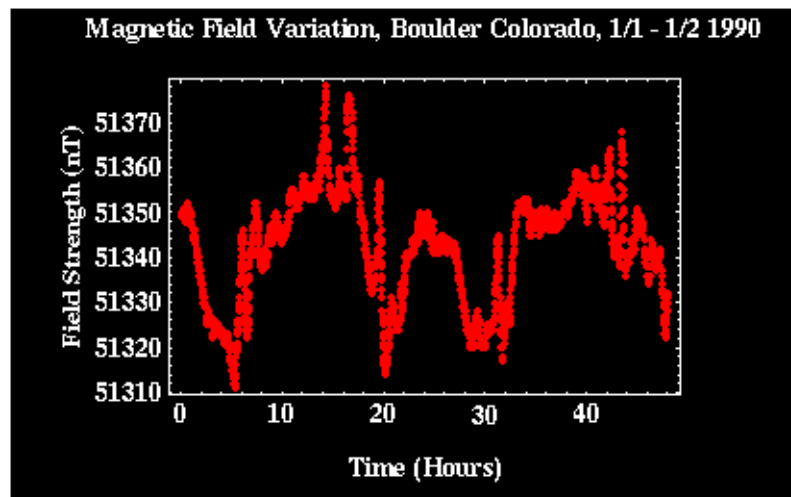
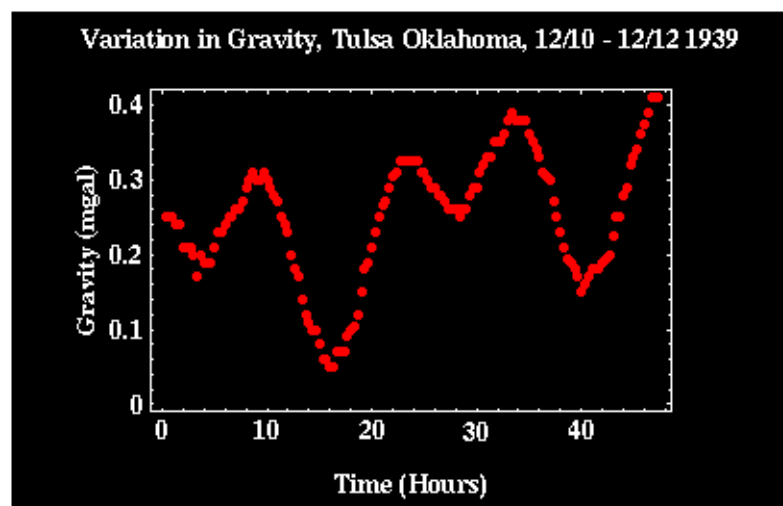

- *Cheap Instruments* - Unlike gravimeters that can cost more than \$25,000, magnetometers are relatively cheap (~\$7,500).
- *Instrument Drift* - Unlike gravimeters, magnetometers show no appreciable instrument drift.

With these points in mind, most investigators conduct magnetic surveys using two magnetometers. One is used to monitor temporal variations of the magnetic field continuously at a chosen [base station](#), and the other is used to collect observations related to the survey proper.

By recording the times at which each magnetic station readings are made and subtracting the magnetic field strength at the base station recorded at that same time, temporal variations in the magnetic field can be eliminated. The resulting field then represents relative values of the variation in total field strength with respect to the magnetic base station.

[FAQ](#)[E-Mail](#)[Home](#)[Next](#)[Last](#)

Spatially Varying Corrections?

When reducing gravity observations, there were a host of spatially varying corrections that were applied to the data. These included [latitude corrections](#), [elevation corrections](#), [slab corrections](#), and [topography corrections](#). In principle, all of these corrections could be applied to magnetic observations also. In practice, the only corrections routinely made for are spatial variations in the Earth's main magnetic field, which would be equivalent to latitude corrections applied to gravity observations. Why aren't the other corrections applied?

Variations in total field strength as a function of elevation are less than 0.015 nT per meter. This variation is generally considered small enough to ignore. Variations in total field strength caused by excess magnetic material (i.e., a slab correction) and topography could, on the other hand, be quite significant. The problem is the large variation in [susceptibilities](#) associated with earth materials even when those materials are of the same rock type.

Recall that in applying the slab and elevation corrections to our gravitational observations, we had to assume an average density for the rocks making up the corrections. [Rock densities](#) do not vary much from rock type to rock type. Density variations of 0.5 gm/cm³ are large. Variations among different samples of the same rock type vary by even less. Therefore, we can assume an average density for the correction and feel fairly confident that our assumption is reasonable.

[Magnetic susceptibilities](#) vary by orders of magnitude even among samples of the same rock type. So, how can we choose an *average* susceptibility on which to base our correction? The answer is we can't. Therefore, instead of applying a set of corrections that we know will be wrong, we apply no correction at all to attempt to account for excess material and topography.

[FAQ](#)[E-Mail](#)[Home](#)[Next](#)[Last](#)

Correcting for Main Field Variations

Corrections for spatial variations in the strength of the Earth's [main magnetic](#) field are referred to as *geomagnetic corrections*. One commonly used method of accounting for these variations is to use one of the many models of the Earth's main magnetic field that are available. One such set of commonly used models of the main field is referred to as the [International Geomagnetic Reference Field \(IGRF\)](#).

The IGRF models are regularly updated to account for [secular variations](#). Given the latitude and longitude of some point on the Earth's surface, the total field strength of the Earth's main magnetic field can be [calculated](#).

Consider a small [two-dimensional survey](#). A plan view of such a survey is shown to the right. One commonly used method of applying the main field correction is to linearly interpolate the computed values of the main field at the corners of the survey throughout the survey region. These interpolated values can then be subtracted from the field observations. After applying this correction, you are left with that portion of the magnetic field that can not be attributed to the Earth's main magnetic field.

This two-dimensional application of linear interpolation is only slightly more complex than the [one-dimensional linear interpolation](#) used to reduce our gravity observations. Values of the Earth's main magnetic field are first determined from the IGRF for each corner point of the survey ($c1$, $c2$, $c3$, $c4$). To determine the strength of the main field at the point p , we first perform two linear interpolations up the edges of the survey in the y direction to determine the values of the field at the points $t1$ and $t2$. That is, first determine the value of the Earth's main magnetic field at the point $t1$ by linearly interpolating between the points $c1$ and $c4$. Then determine the value of the main field at the point $t2$ by linearly interpolating between the points $c2$ and $c3$. Now, linearly interpolate in the x direction between $t1$ and $t2$. The result is the two-dimensionally interpolated value of the field at the point p^* .

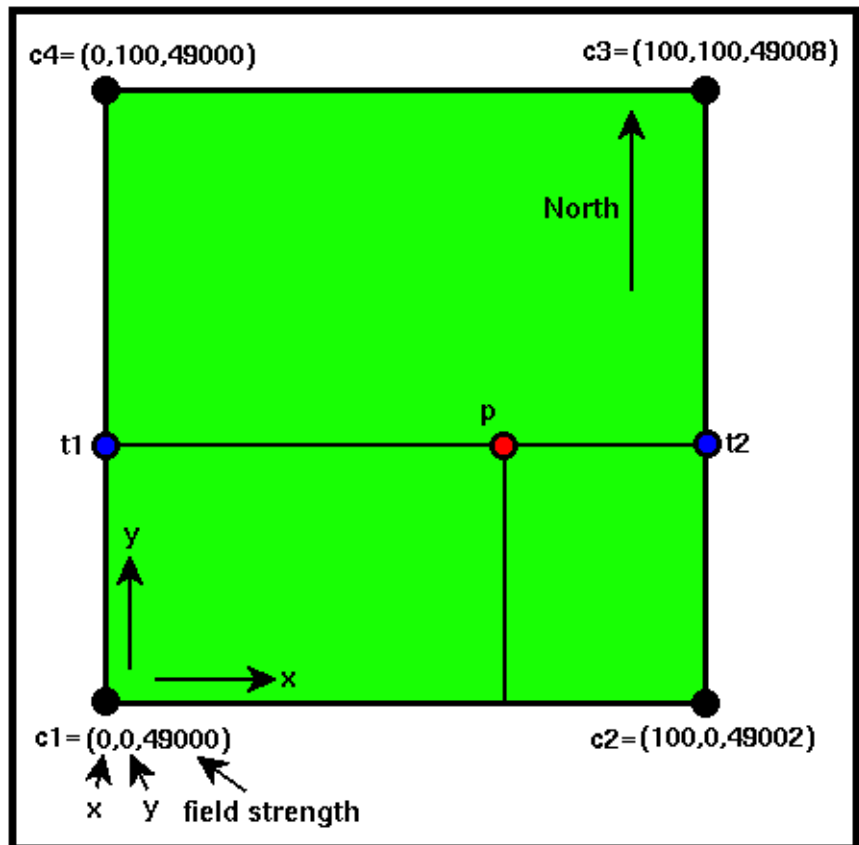

*There is no reason why I have chosen to first interpolate in the y direction and then interpolate in the x direction. I could have first interpolated in the x direction between $c1$ and $c2$ and then between $c3$ and $c4$.

[FAQ](#)
[E-Mail](#)
[Home](#)
[Next](#)
[Last](#)

Comparison Between Gravity and Magnetic Anomalies

Unlike the gravitational [anomalies](#) caused by subsurface density variations, the magnetic [anomalies](#) caused by subsurface variations in magnetic susceptibility are difficult to intuitively construct. This is because there are more factors involved in controlling the shape of a magnetic anomaly than there are in controlling the shape of a gravity anomaly.

In the case of a given subsurface density distribution, the shape of the resulting gravity anomaly is a function of the subsurface density distribution *only*. In fact, knowing the gravitational anomaly produced by a simple shape such as a [point mass](#) is often enough to guess what the shape of the gravity anomaly would be over a much more complicated density distribution. Once you've determined the shape of the gravity anomaly that the density distribution will produce, then you can make reasonable guesses about how the anomaly will change as the density contrast is varied or as the depth to the density contrast is varied. In addition, the anomaly will not change shape if the density distribution is moved to a different location on the Earth, say from the equator to the north pole. The gravity anomaly is a function of density *only*.

Magnetic anomalies, on the other hand, are a function of two independent parameters: the subsurface distribution of susceptibility and the orientation of the Earth's main magnetic field. Change one of these parameters and you change the resulting magnetic anomaly. What this means in practice is that magnetic anomalies over the same susceptibility distribution will be different if the distribution is in a different location, say one located beneath the equator versus one located beneath the north pole. Additionally, the magnetic anomaly over a two-dimensional body such as a tunnel will look different depending on the orientation of the tunnel, say east-west or north-south, even if the magnetic profile is always taken perpendicular to the trend of the tunnel.

With these complexities in mind, we will not spend a great deal of time analyzing the shapes of magnetic anomalies over simple structures; there are many computer programs available that do this quite well. Rather, we will look at several simple examples and qualitatively construct the magnetic anomalies over them so that you can get a better feeling for the complexities involved and for how it might be done in the computer.

[FAQ](#)[E-Mail](#)[Home](#)[Next](#)[Last](#)

Magnetic Anomaly: Magnetized Sphere at the North Pole

Let's now qualitatively construct what the magnetic anomaly of a metallic sphere located beneath the north pole would look like. The geometry of the sphere, the [Earth's main magnetic field](#), the [field lines](#) associated with the anomalous field, the direction and magnitude of the [anomalous field](#), and a plot of the intensity of the anomalous field that would be recorded are shown.

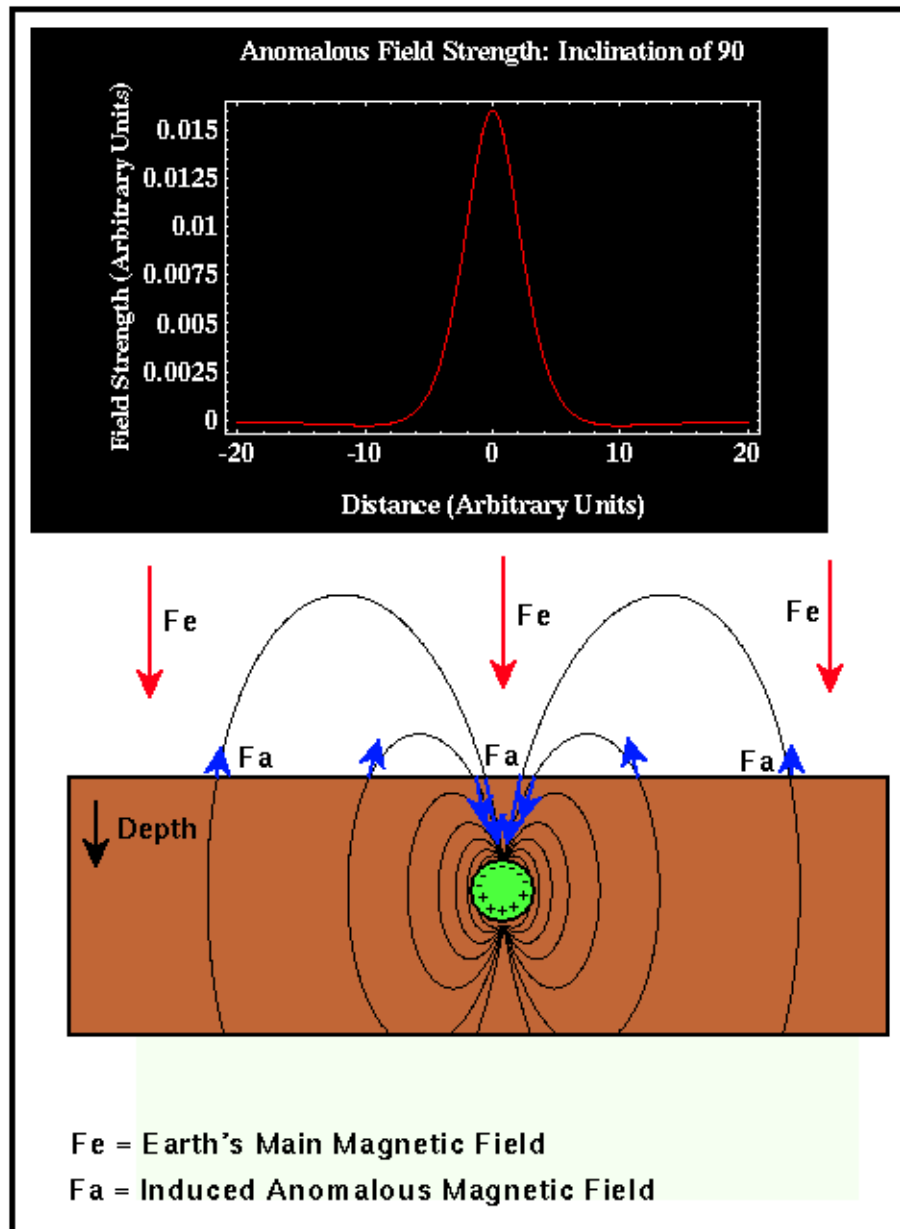

At the north (magnetic) pole, the Earth's main magnetic field, Fe , points straight down. Because the buried sphere is composed of a material with a non-zero [susceptibility](#), the Earth's main magnetic field causes the sphere to produce an [induced](#) magnetic field. Field lines associated with this induced field are shown by black lines, and the magnitude and direction of the induced, anomalous field, Fa , at the surface of the earth are shown by the blue arrows.

The [total field](#), whose strength will be recorded on a [proton precession magnetometer](#), will be sum of the main field, Fe , and the induced, anomalous field, Fa . Notice that to either side of the sphere, the anomalous field points in the opposite

direction as the main field. Thus, when the main field is [removed](#) from our observations we will observe *negative values* for the anomalous field. Near the sphere, the anomalous field points in the same direction as the main field. Therefore, when the main field is removed, we will observe positive values for the anomalous field.

In this case, the anomalous magnetic field is symmetric about the center of the buried sphere, is dominated by a central positive anomaly, and is surrounded on both sides by smaller negative anomalies.

[FAQ](#)[E-Mail](#)[Home](#)[Next](#)[Last](#)

Magnetic Anomaly: Magnetized Sphere at the Equator

Now, let's examine the shape of the anomalous magnetic field for the exact same metallic sphere buried at the equator.

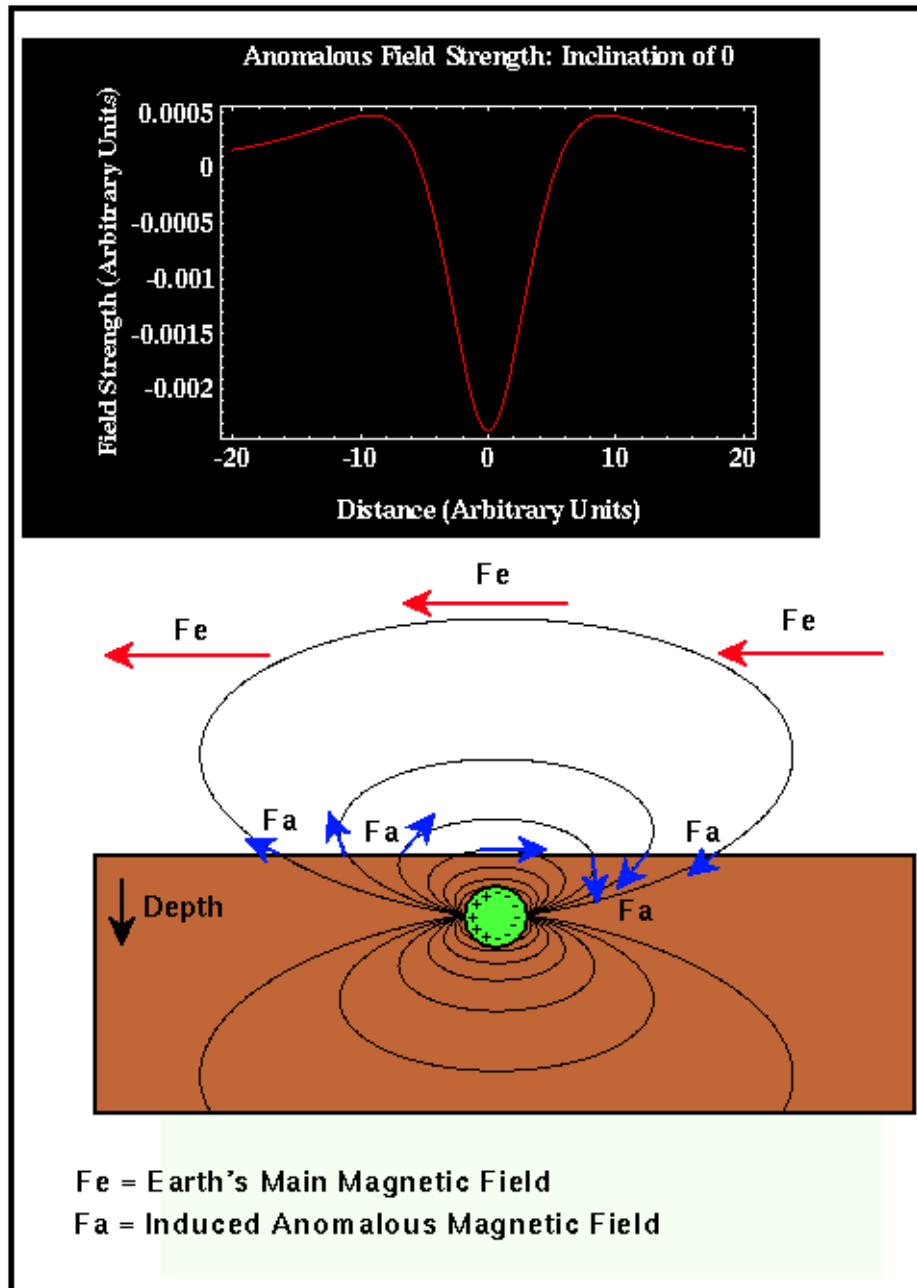

At the equator (magnetic), the direction of the Earth's main magnetic field is now horizontal. It still induces an anomalous magnetic field in the metallic sphere, but the orientation of field lines describing the magnetic field are now rotated 90 degrees. As in the [previous case](#), these field lines are indicated by the black lines, and the strength and direction of the anomalous field at the surface of the earth are shown by the blue arrows. Above the sphere, the anomalous magnetic field, F_a , now points in the opposite direction as the Earth's main magnetic field, F_e . Therefore, the total field measured will be less than the Earth's main field, and so upon removal of the main field, the resulting anomalous field will be negative. On either side of the sphere, the anomalous field points in the general direction of the main field and thus reinforces it resulting in total field measurements that are larger than the Earth's main field. Upon removal of the main field contribution, these areas will show positive magnetic anomalies.

As with the previous case, the resulting anomaly is again symmetrically distributed about the center of the sphere. In this case, however, the prominent central anomaly is negative and is surrounded by two smaller positive anomalies.

[FAQ](#)[E-Mail](#)[Home](#)[Next](#)[Last](#)

Magnetic Anomaly: Magnetized Sphere in the Northern Hemisphere

Finally, let's examine the shape of the anomalous magnetic field for a metallic sphere buried somewhere in the northern hemisphere, say near Denver.

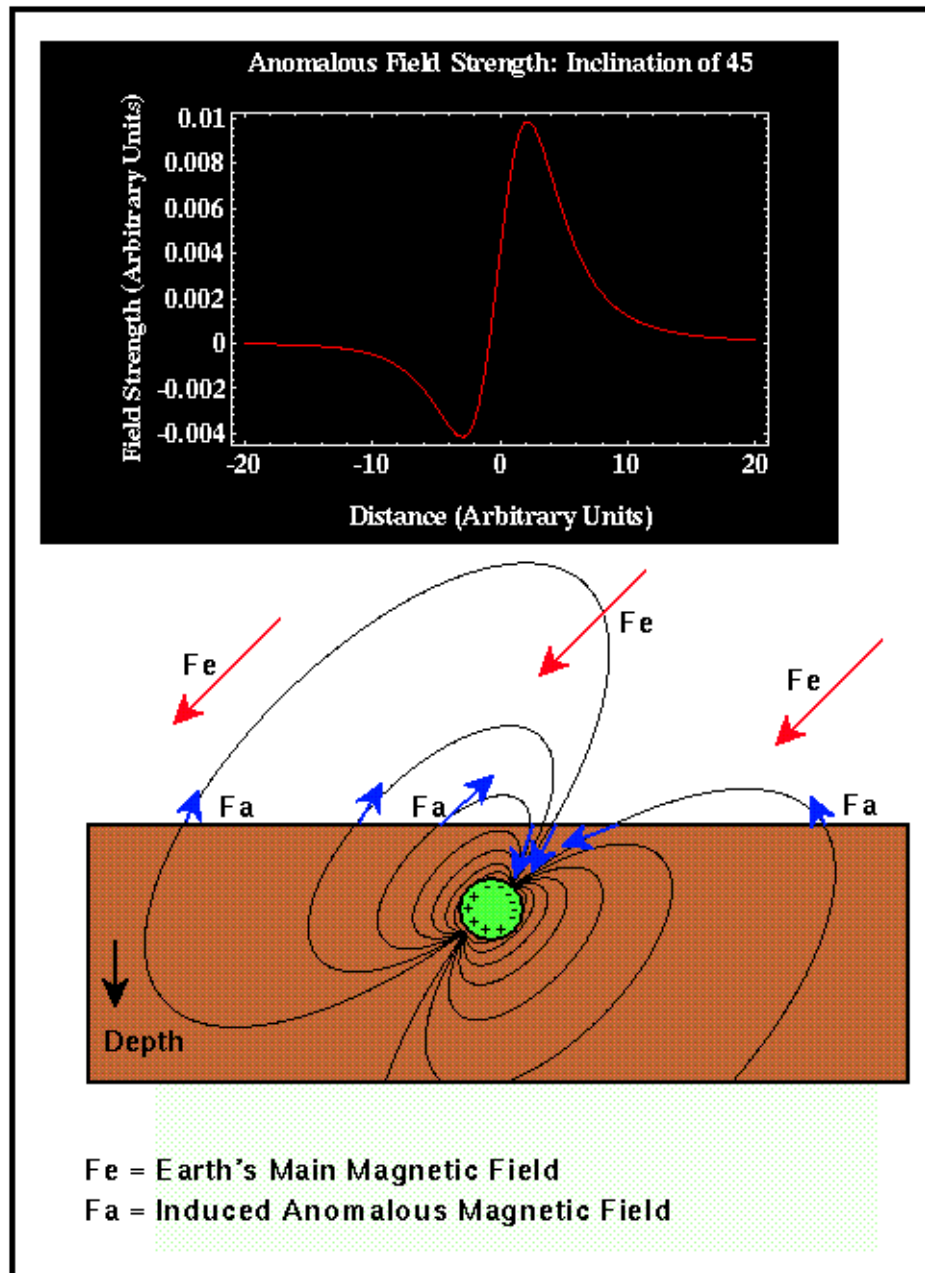

As in the previous examples, the Earth's main magnetic field induces an anomalous field in surrounding the sphere. The anomalous field is now oriented at some angle, in this case 45 degrees, from the horizontal. By looking at the direction of the anomalous field, F_a , in comparison with the Earth's main field, F_e , you can see that there will be a small negative anomaly far to the south of the sphere, a large positive anomaly just south of the sphere, and a small, broad, negative anomaly north of the sphere. Notice that the magnetic anomaly produced is no longer symmetric about the sphere. Unless you are working in one of those special places, like at the magnetic poles or equator, this will always be true.

From this simple set of examples, you now see that it is indeed more difficult to visually interpret magnetic anomalies than gravity anomalies. These visual problems, however, present no problem for the computer modeling algorithms used to model magnetic anomalies. You simply need to incorporate the location of your survey into the modeling algorithm to generate an appropriate magnetic model.

[FAQ](#)[E-Mail](#)[Home](#)[Next](#)[Last](#)