

0% (2) • 525 views • 132 pages

Antennas Rymrsa 2014

Original Title: ANTENNAS RYMSA 2014

Uploaded by **Jose Coellar**

Full description

- Save 0%
- 100%
- Embed
- Share
- Print

Download now

1 of 132

Search document







BROADCAST ANTENNA SYSTEM SOLUTIONS



Since 1974, **RYMSA RF** has specialized implementation of complex broadcast radio antenna systems providing turnkey services for c on all five continents. Our expertise in this field strongly developed over the years leading us t market leadership position, with capabilities to each project from conceptual design to on-site in and commissioning.

RYMSA RF has deployed broadcast antenna from the Equator to the Arctic Circle, providin service in extreme environmental conditions high elevations, strong winds, heavy icing, inte radiation and high levels of humidity and salinity

Customized radiating solutions of high comp one of our specialties. Multi-panel or skew panel large cross-section towers, embedded antenna sys multi-pattern arrays have all been engineered by **R** to satisfy the most difficult antenna pattern require

Multi-channel service and high-power capa common requirements of today's modern broadc **RYMSA RF** antenna systems have the stronges reputation in terms of reliability when these need

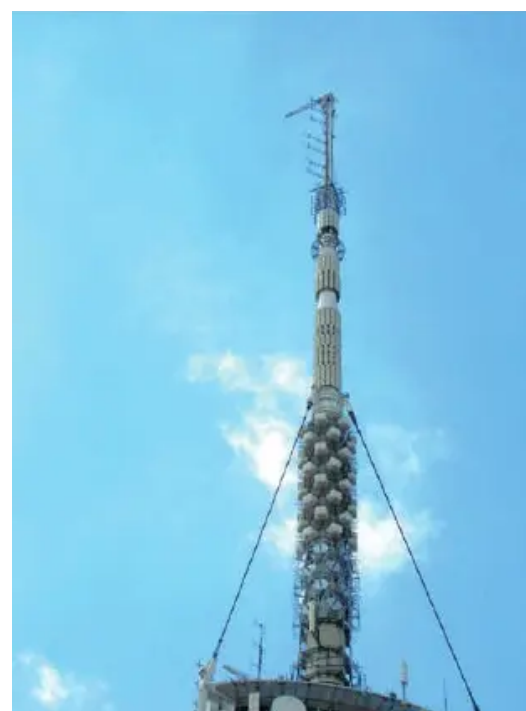



FILTERS AND CHANNEL COMBINERS FOR RADIO AND

RYMSA RF has a successful history of supplying multi-channel combiners to radio and TV broadcasters worldwide. Every possible channel-combining requirement can be achieved with **RYMSA RF** products, ranging from low power applications to very high power systems including large numbers of channels and very close channel spacing.

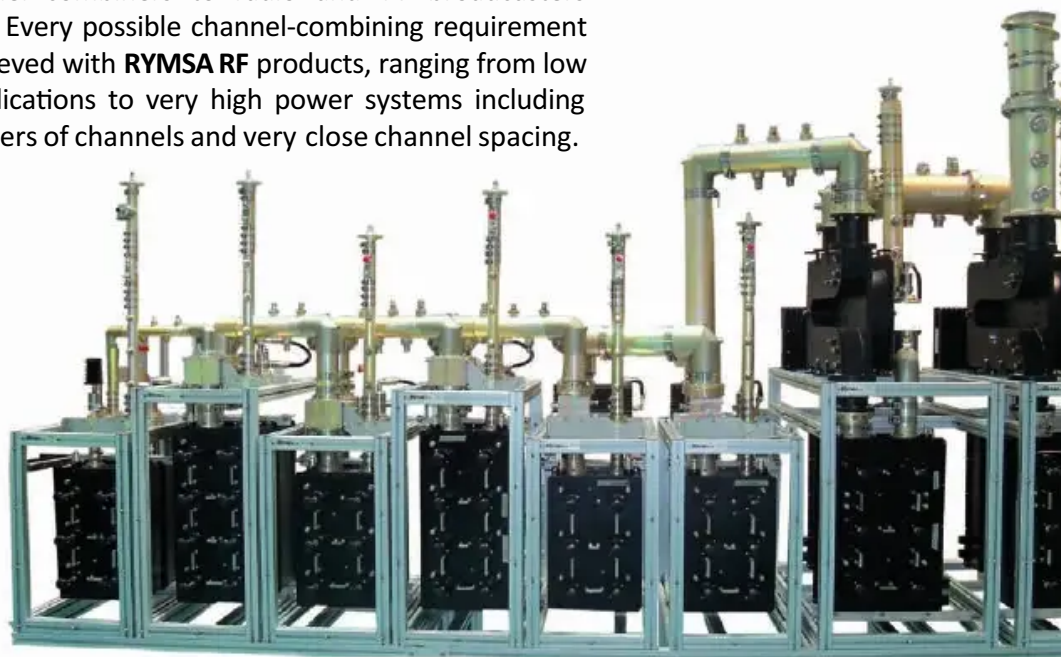

Depending on the needs of each site, **RYMSA RF** can supply different types of combiners such as constant impedance, manifold, star-point or commutating line ("stretch-line"). As per customer request, patch panel systems can be integrated in our channel combiners.

Our expertise includes the ability to provide emissions mask filters for digital TV signals of any standard and any power level. We offer a complete line of re-tunable channel combiners and mask filters that can be tuned to any channel, even for adjacent channel conditions.

In addition to filters and combiners, we supply great

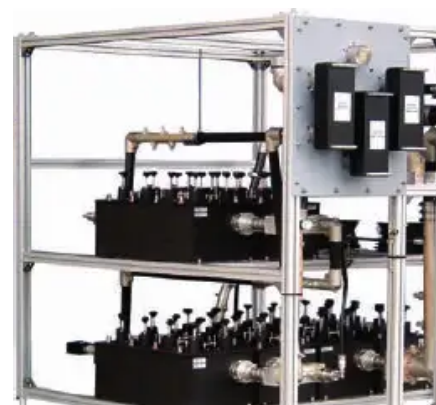



RF DESIGN & ENGINEERING

All key parameters of broadcast RF systems, such as radiation patterns, coverage calculations and RMS and peak power handling are matter of close scrutiny by **RYMSA RF** engineers. Cutting-edge computer-aided design tools enable us to provide optimum results for a wide variety of technical requirements.

In addition to our in-house proprietary software, we have the best commercial design tools available to guarantee the best performance, including SUPERNEC®, CST®, FEKO® and ICS Telecom®. These powerful tools, together with the experience and expertise necessary to use them accurately, guarantee the best possible performance of our products and the best value for the broadcaster.

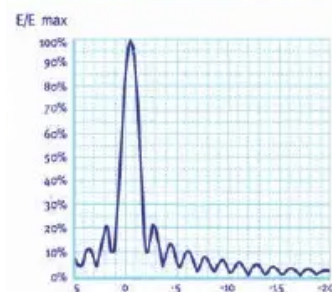
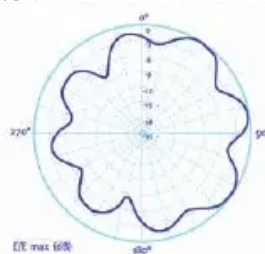
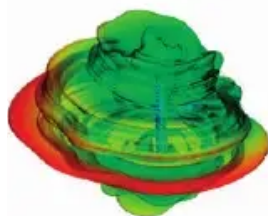

TEST FACILITIES

RYMSA RF is continuously investing in the maintenance and upgrade of in-house test equipment at our manufacturing facilities located in Spain and USA in order to ensure a high level of accuracy in the verification of our designs. All RF components and assemblies designed by **RYMSA RF** are put through stringent electrical, mechanical and environmental testing in our state-of-the-art facilities that include:

- Several far-field antenna ranges and two indoor compact antenna ranges, working from 6 MHz to 40 GHz.
- Network analyzers with a full range of calibration kits for all relevant transmission lines types and sizes.
- RMS and peak power test sets.
- Vibration tables.
- Vacuum chambers.
- Salt spray corrosion chambers.
- Temperature chambers.

The use of these state-of-the-art facilities, in strict accordance with our quality management system endorsed by the DIN EN ISO 9001 Certification, guarantees the highest possible quality of all our products.

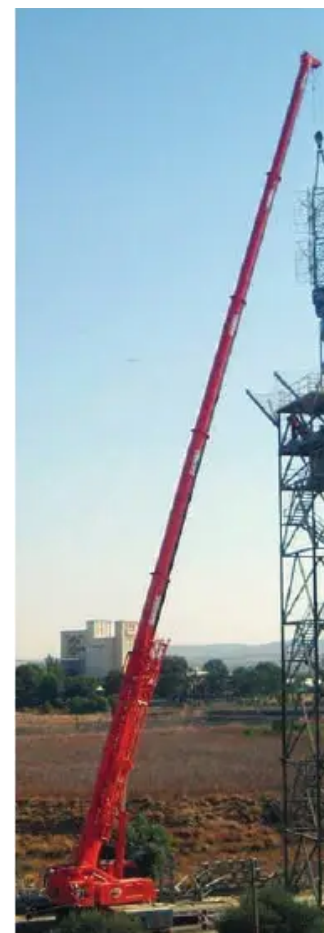



RYMSA RF belongs to TRYO Technologies, a spanish technology group of consolidated companies focused on providing completed solutions to our clients in a wide range of the professional telecommunications and radio frequency applications for broadcast, space, critical communications, scientific and defence.

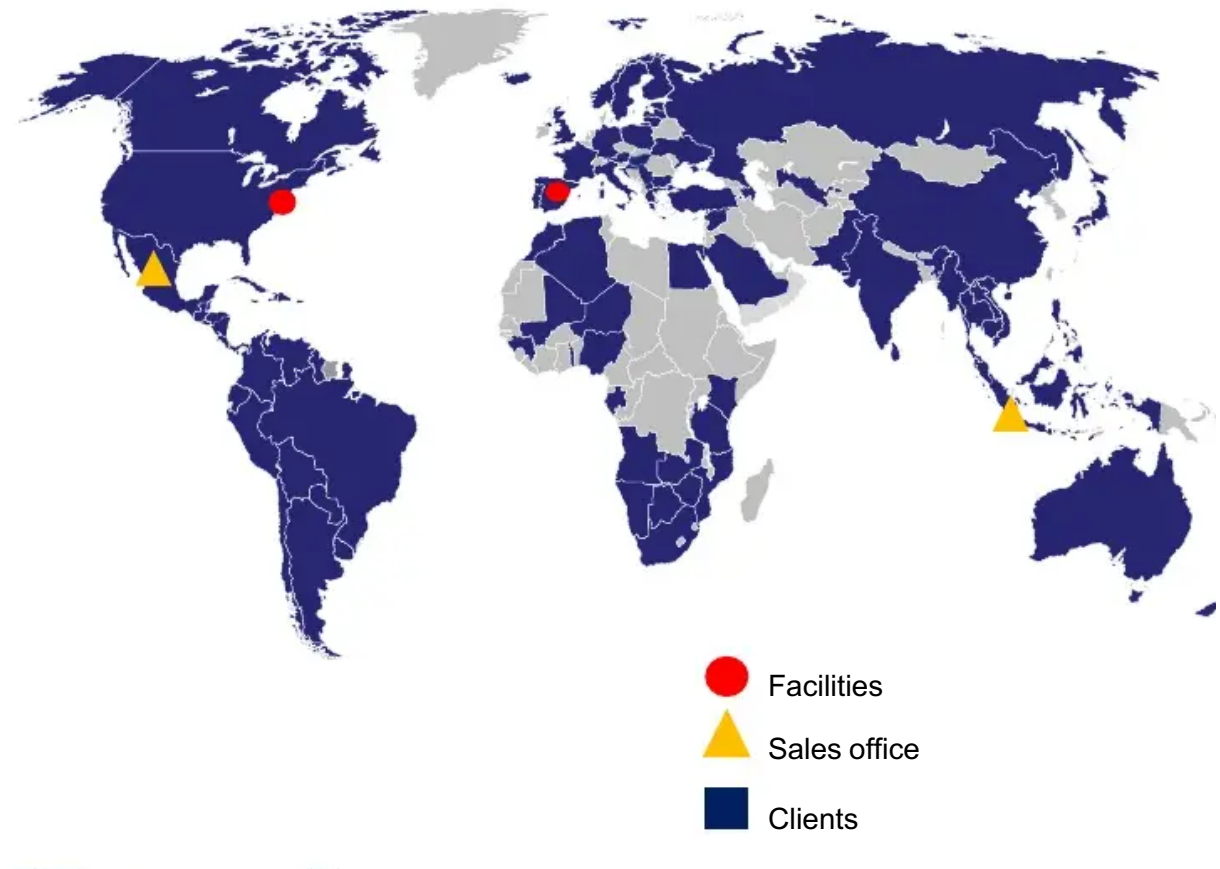

You're reading a preview 

**Unlock full access (pages 8-19) by
uploading documents or with a
30 day free trial**

[Continue for Free](#)

Band III 2 dipoles panel
Especially suitable for square masts
For extreme weather conditions (radome protected)
Model: AT13-222R

Electrical Specifications

Frequency range	174-230 MHz	
Peak gain	7.5 dB (ref. $\lambda/2$ dipole)	
3 dB beam width	E-plane: 66°	H-plane: 61°
Polarization	Horizontal	
Impedance	50 Ohm	
VSWR	≤ 1.15:1	
Maximum power handling peak sync	2 kW	
Maximum power handling RMS	1.4 kW	
Connector type	DIN 7/16	
Pressurization	Non pressurized	

Mechanical & Environmental Specifications

Materials	Radome Reflector & dipoles Isolators	Fiberglass Aluminium PTFE
Dimensions (W x D x H)	1210 x 520 x 1210 mm	
Maximum wind speed	200 Km/h	
Wind load (front)	1680 N (@160 km/h)	
Wind load (lateral)	860 N (@160 km/h)	
Weight	32 Kg	
Typical mounting	Square arrangement tower	
Clamp type	To Ø 80 – 115 mm pipe	
Vertical spacing	1600 mm	
Grounding	DC grounded	
Temperature range	-40°C to +80°C	
Humidity	100%	

Antenna System Characteristics

Number of Bays	Number ant. per bay	Peak gain (dBd)	Weight (Kg)	Wind load (@160 Km/h)	System height (mm)
1	2	5.5	64	2.5 kN	1210
	3	3.7	96	3.4 kN	
	4	2.5	128	3.9 kN	
2	2	8.5	128	5.0 kN	2810
	3	6.7	192	6.8 kN	
	4	5.5	256	7.8 kN	
4	2	11.5	256	10.0 kN	6010
	3	9.7	384	13.6 kN	
	4	8.5	512	15.6 kN	
6	2	13.3	384	15.0 kN	9210
	3	11.5	576	20.4 kN	
	4	10.3	768	23.4 kN	
8	2	14.5	512	20.0 kN	12410
	3	12.7	768	27.2 kN	
	4	11.5	1024	31.2 kN	

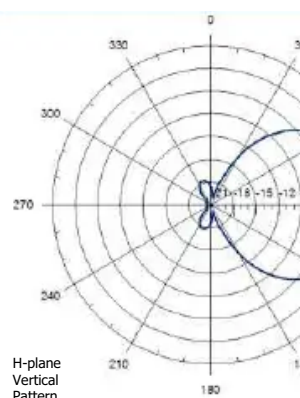
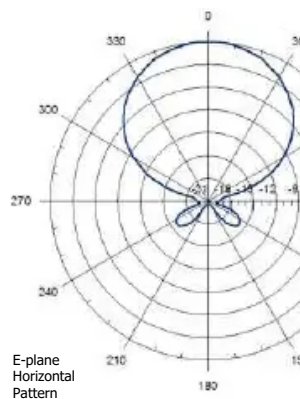
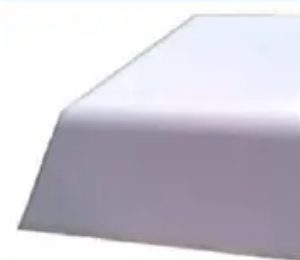

NOTES:

- Table supplies data up to 8 for simplification purposes; sys more bays are available.
- Null fill, beam tilt, harness losses NOT INCLUDED.
- Wind load & weight figure considering cables, splitters & h



Band III 4 dipoles panel Especially suitable for square masts Model: AT13-240

Electrical Specifications

Frequency range	174-230 MHz		
Peak gain	10.5 dB (ref. $\lambda/2$ dipole)		
3 dB beam width	E-plane: 69°	H-plane: 25°	
Polarization	Horizontal		
Impedance	50 Ohm		
VSWR	≤ 1.1:1		
Maximum power handling peak sync	2 kW	3.5 kW	6 kW
Maximum power handling RMS	1.4 kW	2.5 kW	4.2 kW
Connector type	DIN 7/16	EIA 7/8"	DIN 13/30
Pressurization	Non pressurized	Gas barrier on input connector	

Mechanical & Environmental Specifications

Materials	Reflector & dipoles Feed points radome	Hot dip galvanized steel Fiberglass
Dimensions (W x D x H)	1250 x 500 x 2900 mm	
Maximum wind speed	200 km/h	
Wind load (front)	1590 N (@160 km/h)	
Wind load (lateral)	950 N (@160 km/h)	
Weight	68 Kg	
Typical mounting	Square arrangement tower	
Clamp type	To Ø 80 – 115 mm pipe	
Vertical spacing	3200 mm	
Grounding	DC grounded	
Temperature range	-40°C to +80°C	
Humidity	100%	

Antenna System Characteristics

Number of Bays	Number ant. per bay	Peak gain (dBd)	Weight (Kg)	Wind load (@160 Km/h)	System height (mm)
1	2	8.5	136	2.5 kN	2900
	3	6.7	204	3.5 kN	
	4	5.5	272	4.3 kN	
2	2	11.5	272	5.1 kN	6100
	3	9.7	408	7.0 kN	
	4	8.5	544	8.5 kN	
4	2	14.5	544	10.1 kN	12500
	3	12.7	816	13.9 kN	
	4	11.5	1088	17.1 kN	
6	2	16.3	816	15.2 kN	18900
	3	14.5	1224	20.9 kN	
	4	13.3	1632	25.6 kN	
8	2	17.5	1088	20.2 kN	25300
	3	15.7	1632	27.8 kN	
	4	14.5	2176	34.2 kN	

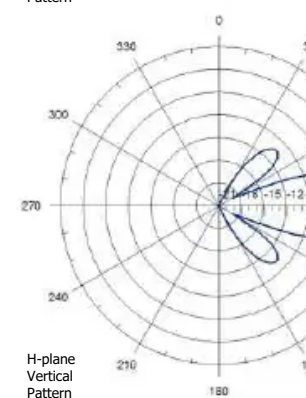
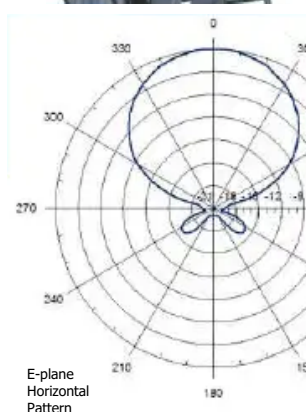

NOTES:

- Table supplies data up to 8 bays for simplification purposes; system bays are available.
- Null fill, beam tilt, harness & f NOT INCLUDED.
- Wind load & weight figures considering cables, splitters & hardware.



Band III 4 dipoles panel
Especially suitable for square masts
Light construction
Model: AT13-242

Electrical Specifications

Frequency range	174-230 MHz	
Peak gain	10.5 dB (ref. $\lambda/2$ dipole)	
3 dB beam width	E-plane: 66°	H-plane: 30°
Polarization	Horizontal	
Impedance	50 Ohm	
VSWR	≤ 1.15:1	
Maximum power handling peak sync	2 kW	
Maximum power handling RMS	1.4 kW	
Connector type	DIN 7/16	
Pressurization	Non pressurized	

Mechanical & Environmental Specifications

Materials	Reflector & dipoles	Hot dip galvanized steel (aluminium construction as option)
	Isolators	PTFE
Dimensions (W x D x H)	1200 x 440 x 2700 mm	
Maximum wind speed	200 km/h	
Wind load (front)	915 N (@160 km/h)	
Wind load (lateral)	505 N (@160 km/h)	
Weight	33 Kg	
Typical mounting	Square arrangement tower	
Clamp type	To Ø 50 – 70 mm pipe	
Vertical spacing	3200 mm	
Grounding	DC grounded	
Temperature range	-40°C to +80°C	
Humidity	100%	

Antenna System Characteristics

Number of Bays	Number ant. per bay	Peak gain (dBd)	Weight (kg)	Wind load (@160 Km/h)	System height (mm)
1	2	8.5	66	1.4 kN	2700
	3	6.7	99	1.9 kN	
	4	5.5	132	2.4 kN	
2	2	11.5	132	2.8 kN	5900
	3	9.7	198	3.9 kN	
	4	8.5	264	4.8 kN	
4	2	14.5	264	5.7 kN	12300
	3	12.7	396	7.7 kN	
	4	11.5	528	9.5 kN	
6	2	16.3	396	8.5 kN	18700
	3	14.5	594	11.6 kN	
	4	13.3	792	14.3 kN	
8	2	17.5	528	11.4 kN	25100
	3	15.7	792	15.4 kN	
	4	14.5	1056	19.1 kN	

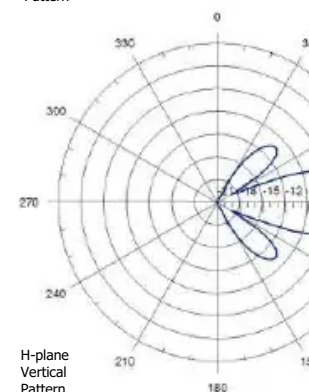
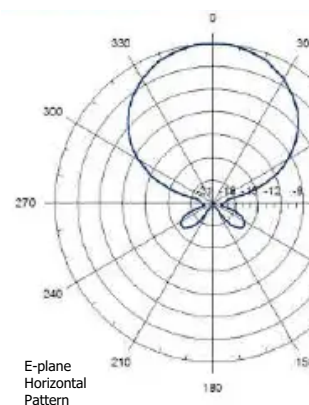
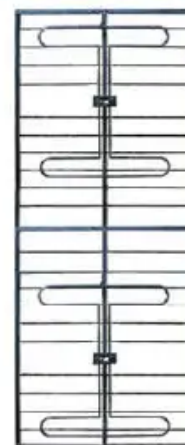

NOTES:

- Table supplies data up to 8 bays for simplification purposes; systems with more than 8 bays are available.
- Null fill, beam tilt, harness & feed cables are NOT INCLUDED.
- Wind load & weight figures are considering cables, splitters & hardware.



Band III 2 dipoles panel Especially suitable for triangular masts Model: AT13-223

Electrical Specifications			
Frequency range	174-230 MHz		
Peak gain	7 dB (ref. $\lambda/2$ dipole)		
3 dB beam width	E-plane: 78°	H-plane: 58°	
Polarization	Horizontal		
Impedance	50 Ohm		
VSWR	$\leq 1.15:1$		
Maximum power handling peak sync	2 kW	3.5 kW	6 kW
Maximum power handling RMS	1.4 kW	2.5 kW	4.2 kW
Connector type	DIN 7/16	EIA 7/8"	DIN 13/30
Pressurization	Non pressurized	Gas barrier on input connector	



Mechanical & Environmental Specifications		
Materials	Reflector & dipoles Feed points radome	Hot dip galvanized steel Fiberglass
Dimensions (W x D x H)	1000 x 530 x 1300 mm	
Maximum wind speed	200 km/h	
Wind load (front)	664 N (@160 km/h)	
Wind load (lateral)	488 N (@160 km/h)	
Weight	36 kg	
Typical mounting	Triangular arrangement tower	
Clamp type	To \varnothing 80 – 115 mm pipe	
Vertical spacing	1600 mm	
Grounding	DC grounded	
Temperature range	-40°C to +80°C	
Humidity	100%	

Antenna System Characteristics					
Number of Bays	Number ant. per bay	Peak gain (dBd)	Weight (kg)	Wind load (@160 Km/h)	System height (mm)
1	2	4.0	72	1.5 kN	1300
	3	2.2	108	2.2 kN	
2	2	7.0	144	3.0 kN	2900
	3	5.2	216	4.3 kN	
4	2	10.0	288	6.0 kN	6100
	3	8.3	432	8.7 kN	
6	2	11.8	432	9.1 kN	9300
	3	10.0	648	13.0 kN	
8	2	13.0	576	12.1 kN	12500
	3	11.3	864	17.4 kN	

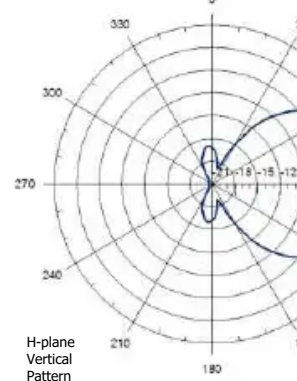
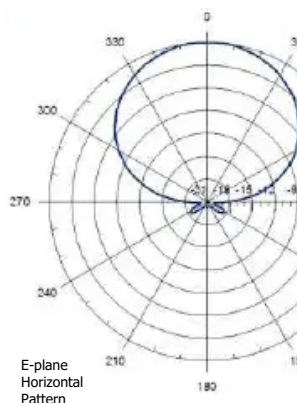

NOTES:

- Table supplies data up to 8 bay simplification purposes; systems more bays are available.
- Null fill, beam tilt, harness losses NOT INCLUDED.
- Wind load & weight figures considering cables, splitters & ha

You're reading a preview 

**Unlock full access (pages 24-26)
by uploading documents or with
a 30 day free trial**

[Continue for Free](#)

Band III 2 dipoles panel
Especially suitable for square masts
For extreme weather conditions (radome protected)
Model: AT13-227R

Electrical Specifications

Frequency range	174-230 MHz
Peak gain	7.5 dB (ref. $\lambda/2$ dipole)
3 dB beam width	E-plane: 66° H-plane: 61°
Polarization	Vertical
Impedance	50 Ohm
VSWR	$\leq 1.15:1$
Maximum power handling peak sync	2 kW
Maximum power handling RMS	1.4 kW
Connector type	DIN 7/16
Pressurization	Non pressurized



Mechanical & Environmental Specifications

Materials	Radome Reflector & dipoles Isolators	Fiberglass Aluminium PTFE
Dimensions (W x D x H)	1210 x 520 x 1210 mm	
Maximum wind speed	200 Km/h	
Wind load (front)	1680 N (@160 km/h)	
Wind load (lateral)	860 N (@160 km/h)	
Weight	32 Kg	
Typical mounting	Square arrangement tower	
Clamp type	To \varnothing 80 – 115 mm pipe	
Vertical spacing	1600 mm	
Grounding	DC grounded	
Temperature range	-40°C to +80°C	
Humidity	100%	

Antenna System Characteristics

Number of Bays	Number ant. per bay	Peak gain (dBd)	Weight (Kg)	Wind load (@160 Km/h)	System height (mm)
1	2	4.5	64	2.5 kN	1210
	3	2.7	96	3.4 kN	
	4	1.5	128	3.9 kN	
2	2	7.5	128	5.0 kN	2810
	3	5.7	192	6.8 kN	
	4	4.5	256	7.8 kN	
4	2	10.5	256	10.0 kN	6010
	3	8.7	384	13.6 kN	
	4	7.5	512	15.6 kN	
6	2	12.3	384	15.0 kN	9210
	3	10.5	576	20.4 kN	
	4	9.3	768	23.4 kN	
8	2	13.5	512	20.0 kN	12410
	3	11.7	768	27.2 kN	
	4	10.5	1024	31.2 kN	

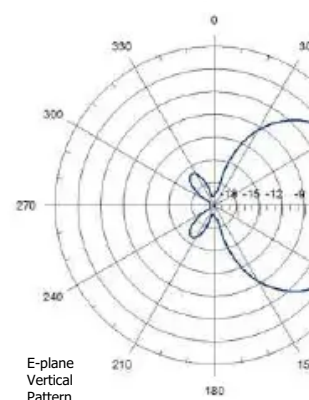

NOTES:

- Table supplies data up to 8 for simplification purposes; sys more bays are available.
- Null fill, beam tilt, harness losses NOT INCLUDED.
- Wind load & weight figure considering cables, splitters & h



Band IV/V horizontal polarization panel Especially suitable for square masts Model: AT15-250

Electrical Specifications				
Frequency range	470-862 MHz			
Peak gain	11.35 dB (ref. $\lambda/2$ dipole)			
3 dB beam width	E-plane: 61°		H-plane: 26°	
Polarization	Horizontal			
Impedance	50 Ohm			
VSWR	≤ 1.1:1 typical (≤ 1.13:1 max)			
Maximum power handling peak sync	1.4 kW	3.5 kW	4.2 kW	6.5 kW
Maximum power handling RMS	1 kW	2.5 kW	3 kW	4.5 kW
Connector type	DIN 7/16	EIA 7/8"	DIN 13/30	EIA 1 5/8"
Pressurization	Non pressurized	Gas barrier on input connector		

Mechanical & Environmental Specifications		
Materials	Reflector & radiating elements	Aluminium (Stainless steel available on request)
	Radome Radome colour	Fiberglass Red or white on request
Dimensions (W x D x H)		483 x 264 x 983 mm
Maximum wind speed		220 km/h
Wind load (front)		743 N (@160 km/h)
Wind load (lateral)		258 N (@160 km/h)
Weight		10 Kg (model with DIN 7/16 connector)
Typical mounting		Several combinations depending on the radiation pattern required (square typical)
Vertical spacing		1000 mm
Grounding		DC grounded
Temperature range		-40°C to +80°C
Humidity		100%

Antenna System Characteristics					
Number of Bays	Number ant. per bay	Peak gain (dBd)	Weight (kg)	Wind load (@160 km/h)	System height (mm)
1	2	8.4	20	1.1 kN	1000
	3	6.6	30	1.6 kN	
	4	5.3	40	1.5 kN	
2	2	11.4	40	2.2 kN	2000
	3	9.6	60	3.2 kN	
	4	8.3	80	3.1 kN	
4	2	14.4	80	4.4 kN	4000
	3	12.6	120	6.4 kN	
	4	11.4	160	6.2 kN	
6	2	16.1	120	6.6 kN	6000
	3	14.4	180	9.6 kN	
	4	13.1	240	9.3 kN	
8	2	17.4	160	8.8 kN	8000
	3	15.6	240	12.8 kN	
	4	14.4	320	12.4 kN	

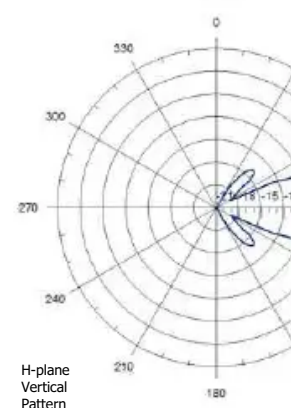
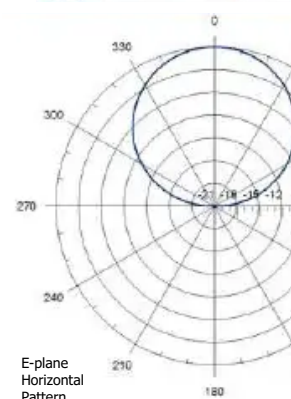

NOTES:

- Table supplies data up to 8 t simplification purposes; system bays are available.
- Null fill, beam tilt, harness & f NOT INCLUDED.
- Wind load & weight figu considering cables, splitters & h



Band IV/V vertical polarization panel Especially suitable for square masts Model: AT15-251

Electrical Specifications				
Frequency range	470-862 MHz			
Peak gain	11.05 dB (ref. $\lambda/2$ dipole)			
3 dB beam width	E-plane: 27°		H-plane: 62°	
Polarization	Vertical			
Impedance	50 Ohm			
VSWR	$\leq 1.15:1$			
Maximum power handling peak sync	1.4 KW	3.5 KW	4.2 KW	6.5 KW
Maximum power handling RMS	1 KW	2.5 KW	3 KW	4.5 KW
Connector type	DIN 7/16	EIA 7/8"	DIN 13/30	EIA 1 5/8"
Pressurization	Non pressurized	Gas barrier on input connector		



Mechanical & Environmental Specifications		
Materials	Reflector & radiating elements	Aluminium
	Radome	Fiberglass
	Radome colour	Red or white on request
Dimensions (W x D x H)		483 x 264 x 983 mm
Maximum wind speed		220 Km/h
Wind load (front)		743 N (@160 Km/h)
Wind load (lateral)		258 N (@160 Km/h)
Weight		9 Kg (model with DIN 7/16 connector)
Typical mounting		Several combinations depending on the radiation pattern required (square typical)
Vertical spacing		1000 mm
Grounding		DC grounded
Temperature range		-40°C to +80°C
Humidity		100%

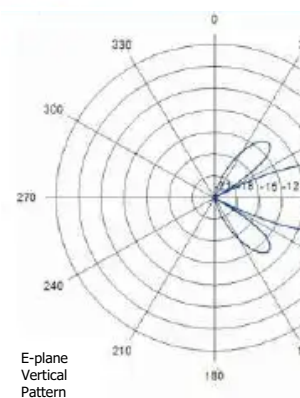
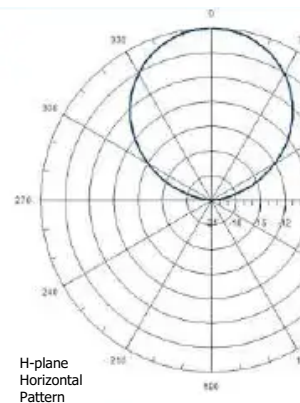

Antenna System Characteristics					
Number of Bays	Number ant. per bay	Peak gain (dBd)	Weight (Kg)	Wind load (@160 Km/h)	System height (mm)
1	2	8.1	18	1.1 kN	1000
	3	6.3	27	1.6 kN	
	4	5.0	36	1.5 kN	
2	2	11.1	36	2.2 kN	2000
	3	9.3	54	3.2 kN	
	4	8.0	72	3.1 kN	
4	2	14.1	96	4.4 kN	4000
	3	12.3	108	6.4 kN	
	4	11.1	144	6.2 kN	
6	2	15.8	108	6.6 kN	6000
	3	14.1	162	9.6 kN	
	4	12.8	216	9.3 kN	
8	2	17.1	144	8.8 kN	8000
	3	15.3	216	12.8 kN	
	4	14.1	288	12.4 kN	

NOTES:

- Table supplies data up to 8 for simplification purposes; sy more bays are available.
- Null fill, beam tilt, harness losses NOT INCLUDED.
- Wind load & weight figur considering cables, splitters & l



Band IV/V slant polarization panel Especially suitable for square masts Model: AT15-252

Electrical Specifications				
Frequency range	470-862 MHz			
Peak gain	12.8 dB (ref. $\lambda/2$ dipole)			
3 dB beam width	E-plane: 61°		H-plane: 26°	
Polarization	Slant (typical 80%H / 20%V)			
Impedance	50 Ohm			
VSWR	≤ 1.1:1 typical (≤ 1.13:1 max)			
Maximum power handling peak sync	1.4 kW	3.5 kW	4.2 kW	6.5 kW
Maximum power handling RMS	1 kW	2.5 kW	3 kW	4.5 kW
Connector type	DIN 7/16	EIA 7/8"	DIN 13/30	EIA 1 5/8"
Pressurization	Non pressurized	Gas barrier on input connector		

Mechanical & Environmental Specifications		
Materials	Reflector & radiating elements	Aluminium (Stainless steel available on request)
	Radome	Fiberglass
	Radome colour	Red or white on request
Dimensions (W x D x H)		483 x 264 x 983 mm
Maximum wind speed		220 km/h
Wind load (front)		743 N (@160 km/h)
Wind load (lateral)		215 N (@160 km/h)
Weight		10 kg (model with DIN 7/16 connector)
Typical mounting		Square arrangement tower
Vertical spacing		1100 mm
Grounding		DC grounded
Temperature range		-40°C to +80°C
Humidity		100%

Antenna System Characteristics					
Number of Bays	Number ant. per bay	Peak gain (dBd)	Weight (kg)	Wind load (@160 km/h)	System height (mm)
1	2	9.8	20	1.0 kN	1094
	3	8.1	30	1.2 kN	
	4	6.8	40	1.4 kN	
2	2	12.8	40	1.9 kN	2194
	3	11.1	60	2.3 kN	
	4	9.8	80	2.8 kN	
4	2	15.8	80	3.8 kN	4394
	3	14.1	120	4.7 kN	
	4	12.8	160	5.7 kN	
6	2	17.6	120	5.8 kN	6594
	3	15.8	180	7.0 kN	
	4	14.6	240	8.5 kN	
8	2	18.9	160	7.7 kN	8794
	3	17.1	240	9.4 kN	
	4	15.8	320	11.4 kN	

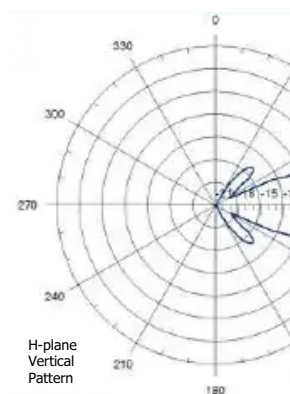
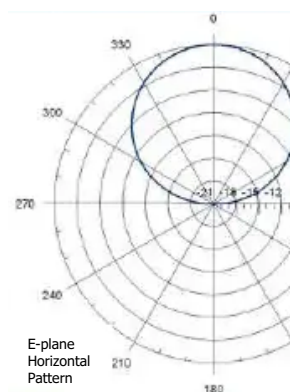

NOTES:

- Table supplies data up to 8 bays for simplification purposes; system bays are available.
- Null fill, beam tilt, harness losses NOT INCLUDED.
- Wind load & weight figures considering cables, splitters & f

The above specifications correspond to the typical 80%H / 20%V polarization ratio

You're reading a preview 

**Unlock full access (page 31) by
uploading documents or with a
30 Day Free Trial**

[Continue for Free](#)

Band IV/V low power superturnstile antennas Model: AT15-801 / 802

UHF Superturnstile Antennas for TV applications offer a broadband omnidirectional radiation pattern with excellent circularity, combined with a minimum wind load impact on the supporting mast.

These antenna systems are ideal for top-mounting, and they are supplied ready for installation, fully assembled and enclosed in a GRP cylinder.

Electrical Specifications

	AT15-801	AT15-802
Frequency range	470-860 MHz	
VSWR	≤ 1.15:1	
Impedance	50 Ohm	
Polarization	Horizontal	
Peak gain (ref. $\lambda/2$ dipole)	1 Bay 5 dBd	2 Bays 8 dBd
3 dB vertical beam width (mid-band)	25°	11°
Maximum power handling RMS	2 kW	4 kW
Connector type ⁽¹⁾	EIA 7/8" female	EIA 1 5/8" female
Pressurization	Not pressurized	

Mechanical & Environmental Specifications

Materials	Batwings	Aluminium
	Connectors	Aluminium and brass
	Isolators	PTFE
	Radome	Fiberglass
Radome dimensions (Ø X H)	318 x 1200 mm	318 x 2500 mm
Weight	26 Kg	46 Kg
Wind Load @ 160 Km/h	323 N	726 N
Maximum wind speed	220 km/h	
Grounding	DC grounded	
Temperature range	-40°C to +70°C	
Humidity	100%	



AT15-801 Superturnstile ant

NOTES:

(1) Other connector types unc request.

Others gain values and pow can be supplied. Please, ask R

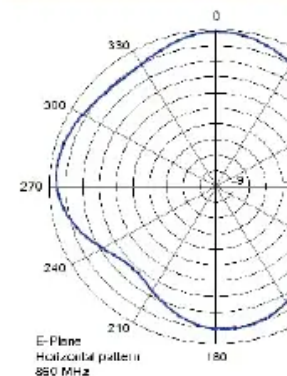
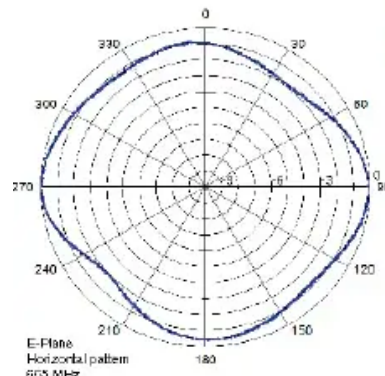
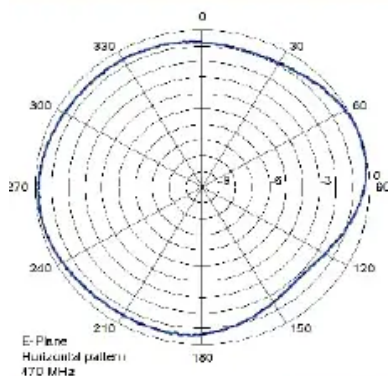



Band IV/V slot antennas Suitable for top-mount or side-mount Series: AT15-9XX

Slot antennas for UHF TV applications are a neat way to provide broadcasting solutions minimizing the visual and mechanical impact over its supporting structure. These antennas are constructed fully enclosed in a cylindrical fiberglass radome, featuring very reduced weight and windload figures, while keeping optimum radioelectrical performances under most severe environmental conditions.

They are ready for installation in top-mount and side-mount configurations, offering a very wide scope of radiating characteristics depending on the polarization (horizontal, circular, elliptical), on the shape of the horizontal radiation pattern, and on the vertical aperture.

AT15-9XX series cover all the possible needs from low power/ low gain solutions up to 16 KW RMS and high gain.

Electrical Specifications

Frequency range	470-806 MHz
Multichannel versions available	Yes
VSWR	$\leq 1.1:1$ across a single channel
Polarization	Horizontal / Circular / Elliptical
Beam tilt & Null Fill	Customized under request
Impedance	50 Ohm
Number of bays	From 4 to 24 bays
Maximum power handling peak sync	From 500 W to 25 KW
Maximum power handling RMS	From 350 W to 16 KW
Connector type	EIA 1 5/8" or EIA 3 1/8"

Mechanical & Environmental Specifications

Radome	Fiberglass (included)
Height (for 4 bays and 24 bays)	From 2400 mm to 13060 mm
Grounding	DC grounded
Temperature range	-40°C to +80°C
Humidity	100%



NOTES:

Note: Mechanical data supplied to channel 30 FCC. Ask RYMSA for others horizontal patterns

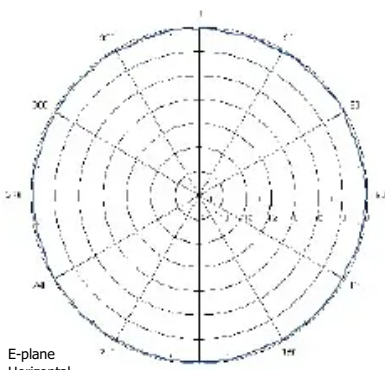

E-plane
Horizontal
Pattern
650 MHz

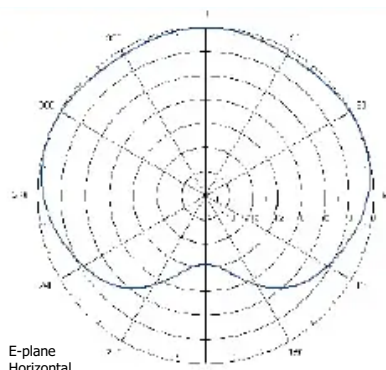

E-plane
Horizontal
Pattern
650 MHz

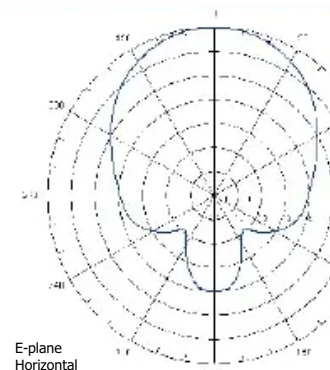

E-plane
Horizontal
Pattern
650 MHz



Radio antenna systems

RYMSA RF manufactures a broad range of antennas for the transmission of radio signals in B-II (FM IBOC) and B-III (DAB).

Antenna systems are currently formed by stacking single radiating elements properly disposed and fed with the adequate phase and amplitude. These unitary radiators can be either directional, as those based on panel cavity solutions, or dipole-style providing omni or quasi-omnidirectional performances.

RYMSA RF designs the single antenna elements succeeding in the challenge of displaying the necessary ruggedness minimizing wind load and weight, and ready to remain weatherproof for a long life withstanding a sort of extreme climatic conditions. This versatility allows using them also individually for simple needs such as remote sites.

Power dividers and interconnecting lines (both flexible and rigid), are utilized to build the distribution network which transports the signals from the main transmission line up to each radiating element. The vast assortment range of different models of these products manufactured by RYMSA RF ensures the capability of satisfying any possible request, from simple arrays to complex high power antenna systems.

RYMSA RF AT12 series offers an extensive range of radiating elements for applications in FM and IBOC radio. Digital radio needs in DAB B-III are covered by AT13 (included at TV Antenna Systems section of this catalog) and AT14 series.

Panel and Cavity Systems

These arrays are the most versatile solution to implement radiation patterns customized to any particular coverage requirement. Ideal for middle to big masts and multichannel operation, they also allow reaching the high power ratings frequently required in those situations. They can be classified as follows:

- **FM and IBOC:** horizontal, vertical and circular polarization panels are provided with several input connector sizes to reach any requested power handling. This assorted range is complemented by the back cavity model for circular polarization. Elliptical polarization is easily achievable as well. Linearly polarized unitary antennas have one input connector, whilst the circularly polarized ones display two and four connectors.

Triangular, square and multi-panel arrays can be easily implemented with RYMSA RF AT12 series directional antennas.

- **DAB:** AT13 series panels, included in this catalog at the TV Antenna Systems section, are available for the transmission of digital radio in B-III. A special panel model, with reduced bandwidth just for the DAB range is also available.



FM circularly polarized antenna system as an array of back-cavity unitary radiators



FM panel antenna for triangular mast assembled in-plant for factory test

You're reading a preview 

**Unlock full access (pages 36-52)
by uploading documents or with
a 30 day free trial**

[Continue for Free](#)

Band II 2 crossed dipoles cavity Especially suitable for square masts Model: AT12-321

Electrical Specifications

Frequency Range	87.5-108 MHz		
Peak gain	7.2 dB (ref. $\lambda/2$ dipole)		
3 dB beam width	Horizontal: 68°	Vertical: 68°	
Polarization	Circular / Elliptical		
Impedance	50 Ohm		
VSWR	≤ 1.1:1 (with circular polarization)		
Maximum power handling (per connector)	5 kW (2.5 kW)	10 kW (5 kW)	14 kW (7 kW)
Connector type (2 per antenna)	2 x DIN 7/16	2 x EIA 7/8"	2 x DIN 13/30
Pressurization	Non pressurized	Gas barrier on input connector	
	Fully pressurized as an option		

Mechanical & Environmental Specifications

Materials	Hot dip galvanized steel
Dimensions (W x D x H)	2700 x 986 x 2700 mm
Maximum wind speed	200 km/h
Wind load (front)	2320 N (@160 km/h)
Wind load (lateral)	1273 N (@160 km/h)
Weight	101 Kg
Typical mounting	Square arrangement tower
Clamp type	To Ø 80 – 115 mm pipe
Vertical spacing	2800 mm
Grounding	DC grounded
Temperature range	-40°C to +80°C
Humidity	100%

Antenna System Characteristics

Number of Bays	Number ant. per bay	Peak gain (dBd)	Weight (Kg)	Wind load (@160 Km/h)	System height (mm)
1	2	5.4	202	3.6 kN	2700
	3	3.7	303	4.9 kN	
	4	2.6	404	6.0 kN	
2	2	8.4	404	7.2 kN	5500
	3	6.7	606	9.7 kN	
	4	5.6	808	12.1 kN	
4	2	11.4	808	14.4 kN	11100
	3	9.7	1212	19.5 kN	
	4	8.6	1616	24.1 kN	
6	2	12.8	1212	21.6 kN	16700
	3	11.5	1818	29.2 kN	
	4	10.4	2424	36.2 kN	
8	2	14.4	1616	28.7 kN	22300
	3	12.7	2424	38.9 kN	
	4	11.6	3232	48.2 kN	

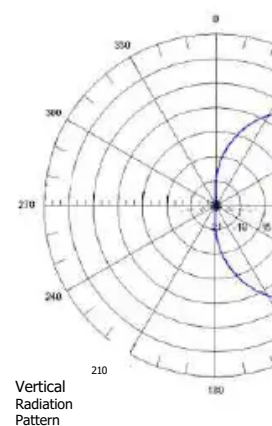
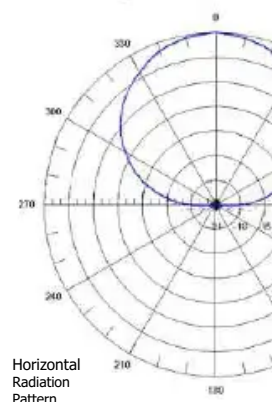

NOTES:

- Table supplies data up to 8 bays for simplification purposes; systems with more than 8 bays are available.
- Null fill, beam tilt, harness losses NOT INCLUDED.
- Wind load & weight figures considering cables, splitters & h...



DAB Dipole Antenna Side-Mount Installation Model: AT14-512

Electrical Specifications

Frequency range	216-240 MHz
Peak gain	0 dB (ref. $\lambda/2$ dipole) 2.2 dB (ref. $\lambda/2$ dipole, with pole)
3 dB beam width	E-plane: 79° H-plane: 200°
Polarization	Vertical
Impedance	50 Ohm
VSWR	$\leq 1.15:1$
Maximum power handling RMS	1.5 kW
Connector type	DIN 7/16
Pressurization	Non pressurized

Mechanical & Environmental Specifications

Materials	Dipole Isolators	Hot dip galvanized steel PTFE
Dimensions (W x D x H)	50 x 690 x 650 mm	
Maximum wind speed	200 Km/h	
Wind load (front)	38 N (@160 km/h)	
Wind load (lateral)	106 N (@160 km/h)	
Weight	9 kg	
Clamp type	To $\varnothing 80 - 100$ mm pipe	
Vertical spacing	$0.8 \lambda - 0.9 \lambda$ typical	
Grounding	DC grounded	
Temperature range	-40°C to $+80^{\circ}\text{C}$	
Humidity	100%	

Antenna System Characteristics

Number of Bays	Number ant. per bay	Peak gain (dBd)	Weight (kg)	Wind load (@160 km/h)	System height (mm)
1	1	2.2	9	0.11 kN	650
2	1	5.2	18	0.21 kN	1768
4	1	8.2	36	0.42 kN	4005
6	1	10.0	54	0.64 kN	6242
8	1	11.2	72	0.85 kN	8479
10	1	12.2	90	1.06 kN	10712
12	1	13.0	108	1.27 kN	12948

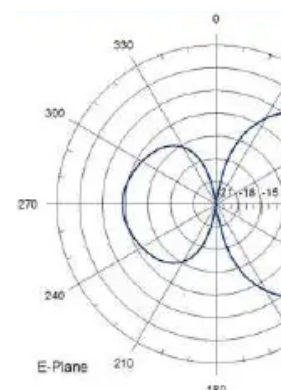
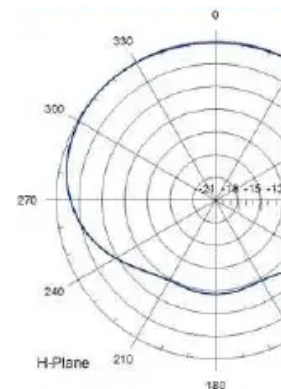

NOTES:

- Radiation patterns and gain in the table are including the supporting pole
- Null fill, beam tilt, harness losses NOT INCLUDED
- Wind load & weight figures considering cables, splitters & h



DAB Dipole Antenna Side-Mount Installation For extreme weather conditions Model: AT14-522

Electrical Specifications

Frequency range	216-240 MHz	
Peak gain	0 dB (ref. $\lambda/2$ dipole) 2.2 dB (ref. $\lambda/2$ dipole, with pole)	
3 dB beam width	E-plane: 79°	H-plane: 200°
Polarization	Vertical	
Impedance	50 Ohm	
VSWR	$\leq 1.2:1$	
Maximum power handling RMS	1.5 kW	
Connector type	DIN 7/16	
Pressurization	Non pressurized	

Mechanical & Environmental Specifications

Materials	Dipole Feed points radome	Hot dip galvanized steel Fiberglass
Dimensions (W x D x H)	50 x 460 x 560 mm	
Maximum wind speed	200 Km/h	
Wind load (front)	38 N (@160 km/h)	
Wind load (lateral)	128 N (@160 km/h)	
Weight	12 Kg	
Clamp type	To \varnothing 80 – 100 mm pipe	
Vertical spacing	0.8 λ – 0.9 λ typical	
Grounding	DC grounded	
Temperature range	-40°C to +80°C	
Humidity	100%	

Antenna System Characteristics

Number of Bays	Number ant. per bay	Peak gain (dBd)	Weight (kg)	Wind load (@160 km/h)	System height (mm)
1	1	2.2	12	0.13 kN	560
2	1	5.2	24	0.26 kN	1678
4	1	8.2	48	0.51 kN	3915
6	1	10.0	73	0.77 kN	6152
8	1	11.2	96	1.02 kN	8389
10	1	12.2	120	1.27 kN	10622
12	1	13.0	144	1.53 kN	12858

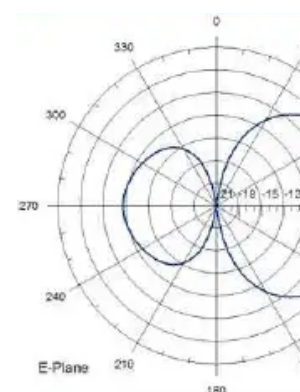
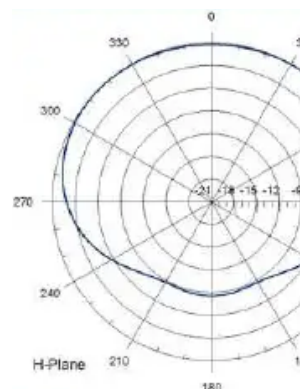

NOTES:

- Radiation patterns and gain value are including the effect of pole
- Null fill, beam tilt, harness & feed NOT INCLUDED
- Wind load & weight figure considering cables, splitters & harness

You're reading a preview 

**Unlock full access (pages 57-62)
by uploading documents or with
a 30 day free trial**

[Continue for Free](#)

UHF band IV-V DTV mask filter
Typical power: 150 W digital
Bandpass filter
Model: FLDV-016

Electrical Specifications

Filter type	Bandpass coaxial	
Order	6 poles with internal feedback	
Cavity size	55 mm	
Frequency range	470-862 MHz	
Mask type	Non critical	
Impedance	50 Ohm	
Channel bandwidth	6, 7, 8 MHz	
Maximum power handling ⁽¹⁾	150 W RMS	
Connectors	DIN 7/16 (F)	
VSWR	≤ 1.22:1	
Frequency response ⁽²⁾	474 MHz	858 MHz
f_0	≤ 1.0 dB	≤ 1.2 dB
$f_0 \pm 3.8$ MHz	≤ 1.9 dB	≤ 2.3 dB
$f_0 \pm 4.2$ MHz	> 4 dB	> 4 dB
$f_0 \pm 6$ MHz	> 20 dB	> 20 dB
$f_0 \pm 12$ MHz	> 40 dB	> 40 dB
Group delay variation	≤ 350 ns	
Thermal stability	≤ 2 kHz / °C	



FLDV-016 bandpass filter

Mechanical & Environmental Specifications

Dimensions (W x D x H)	121 x 290 x 200 mm	
Materials	Outer conductor	Copper
	Inner conductor	Silver plated brass
	Tuning elements	Silver plated brass
	Isolators	PTFE
	Finishing	Long lasting black paint
	Screws	Stainless steel
Temperature range	-10°C to +50°C	

NOTES:

(1): See section Environmental for an accurate application handling data.

(2): Other frequency respons supplied. Please, ask RYMSA RI

The filter can be field returned to any channel within specified band



UHF band IV-V DTV mask filter
Typical power: 150 W digital
Bandpass filter
Model: FLDV-018

Electrical Specifications		
Filter type	Bandpass coaxial	
Order	8 poles with internal feedback	
Cavity size	55 mm	
Frequency range	470-862 MHz	
Mask type	Critical	
Impedance	50 Ohm	
Channel bandwidth	6, 7, 8 MHz	
Maximum power handling ⁽¹⁾	150 W RMS	
Connectors	DIN 7/16 (F)	
VSWR	≤ 1.22:1	
Frequency response ⁽²⁾	474 MHz	858 MHz
f_0	≤ 1.6 dB	≤ 1.9 dB
$f_0 \pm 3.8$ MHz	≤ 2.8 dB	≤ 4.0 dB
$f_0 \pm 4.2$ MHz	> 8 dB	> 8 dB
$f_0 \pm 6$ MHz	> 40 dB	> 40 dB
$f_0 \pm 12$ MHz	> 55 dB	> 50 dB
Group delay variation	≤ 400 ns	
Thermal stability	≤ 2 kHz / °C	



FLDV-018 bandpass filter

Mechanical & Environmental Specifications		
Dimensions (W x D x H)	121 x 345 x 200 mm	
Materials	Outer conductor	Copper
	Inner conductor	Silver plated brass
	Tuning elements	Silver plated brass
	Isolators	PTFE
	Finishing	Long lasting black paint
	Screws	Stainless steel
Temperature range	-10°C to +50°C	

NOTES:

(1): See section Environmental for an accurate application handling data.

(2): Other frequency responses supplied. Please, ask RYMSA RF

The filter can be field retuned to any channel within specified band



UHF band IV-V DTV mask filter
Typical power: 1.9 kW digital
Bandpass filter
Model: FLDV-116

Electrical Specifications	
Filter type	Bandpass coaxial
Order	6 poles with internal feedback
Cavity size	100 mm
Frequency range	470-862 MHz
Mask type	Non critical
Impedance	50 Ohm
Channel bandwidth	6, 7, 8 MHz
Maximum power handling ⁽¹⁾	1900 W RMS
Connectors	DIN 7/16 (F) or 1 5/8" unflanged
VSWR	≤ 1.15:1
Group delay variation	≤ 350 ns
Thermal stability	≤ 2 kHz / °C

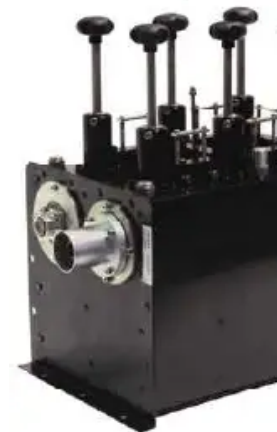

FLDV-116 bandpass filter

Mechanical & Environmental Specifications		
Dimensions (W x D x H)	214 x 355 x 401 mm	
Weight	15 kg	
Materials	Outer conductor	Copper
	Inner conductor	Silver plated aluminium and brass
	Tuning elements	Invar and silver plated aluminium and brass
	Isolators	PTFE
	Finishing	Long lasting black paint
	Screws	Stainless steel
Temperature range	-10°C to +50°C	

Frequency Responses ⁽²⁾		
Channel bandwidth 8 MHz (typical DVB-T)		
	474 MHz	858 MHz
f_0	≤ 0.45 dB	≤ 0.6 dB
$f_0 \pm 3.8$ MHz	≤ 1.0 dB	≤ 1.6 dB
$f_0 \pm 4.2$ MHz	> 4 dB	> 4 dB
$f_0 \pm 6$ MHz	> 20 dB	> 20 dB
$f_0 \pm 12$ MHz	> 40 dB	> 40 dB
Channel bandwidth 6 MHz (typical ATSC)		
	473 MHz	803 MHz
f_0	≤ 0.5 dB	≤ 0.7 dB
$f_0 \pm 2.69$ MHz	≤ 0.55 dB	≤ 0.8 dB
$f_0 \pm 3$ MHz	≤ 0.6 dB	≤ 0.85 dB
$f_0 \pm 4$ MHz	> 5.5 dB	> 5.5 dB
$f_0 \pm 5$ MHz	> 18 dB	> 18 dB
$f_0 \pm 6$ MHz	> 30 dB	> 30 dB
$f_0 \pm 9$ MHz	> 64 dB	> 64 dB

NOTES:

(1): See section Environmental for an accurate application handling data.

(2): Other frequency responses supplied. Please, ask RYMSA RI

Optional Accessories	
Directional couplers at input and output	
Rack mounted	



UHF band IV-V DTV mask filter
Typical power: 1.6 kW digital
Bandpass filter
Model: FLDV-118

Electrical Specifications	
Filter type	Bandpass coaxial
Order	8 poles with internal feedback
Cavity size	100 mm
Frequency range	470-862 MHz
Mask type	Critical
Impedance	50 Ohm
Channel bandwidth	6, 7, 8 MHz
Maximum power handling ⁽¹⁾	1600 W RMS
Connectors	DIN 7/16 (F) or 1 5/8" unflanged
VSWR	≤ 1.15:1
Group delay variation	≤ 350 ns
Thermal stability	≤ 2 kHz / °C



FLDV-116 bandpass filter

Mechanical & Environmental Specifications		
Dimensions (W x D x H)	214 x 455 x 401 mm	
Weight	21 kg	
Materials	Outer conductor	Copper
	Inner conductor	Silver plated aluminium and brass
	Tuning elements	Invar and silver plated aluminium and brass
	Isolators	PTFE
	Finishing	Long lasting black paint
Screws	Stainless steel	
Temperature range	-10°C to +50°C	

Frequency Responses ⁽²⁾		
Channel bandwidth 8 MHz (typical DVB-T)		
	474 MHz	858 MHz
f_0	≤ 0.55 dB	≤ 0.8 dB
$f_0 \pm 3.8$ MHz	≤ 2.10 dB	≤ 3.1 dB
$f_0 \pm 4.2$ MHz	> 15 dB	> 15 dB
$f_0 \pm 6$ MHz	> 40 dB	> 40 dB
$f_0 \pm 12$ MHz	> 60 dB	> 60 dB
Channel bandwidth 6 MHz (typical ISDB-T)		
	473 MHz	803 MHz
f_0	≤ 0.65 dB	≤ 1.0 dB
$f_0 \pm 2.79$ MHz	≤ 2.10 dB	≤ 2.6 dB
$f_0 \pm 3.15$ MHz	> 15 dB	> 15 dB
$f_0 \pm 4.5$ MHz	> 35 dB	> 35 dB
$f_0 \pm 9$ MHz	> 60 dB	> 60 dB

NOTES:

(1): See section Environment for an accurate applicator handling data.

(2): Other frequency responses supplied. Please, ask RYMSA I

Optional Accessories
Directional couplers at input and output
Rack mounted

The filter can be field retuned to any channel within specified band



UHF band IV-V DTV mask filter
Typical power: 3.5 - 6 kW digital
Bandpass filter
Model: FLDV-156

Electrical Specifications	
Filter type	Bandpass coaxial
Order	6 poles with internal feedback
Cavity size	150 mm
Frequency range	470-862 MHz
Mask type	Non critical
Impedance	50 Ohm
Channel bandwidth	6, 7, 8 MHz
Maximum power handling ⁽¹⁾	
Without liquid cooling	3500 W (8 MHz bandwidth) 3000 W (6 MHz bandwidth)
With optional liquid cooling	6000 W (8 MHz bandwidth) 4700 W (6 MHz bandwidth)
Connectors	Unflanged 1 5/8"
VSWR	≤ 1.15:1
Group delay variation	≤ 350 ns
Thermal stability	≤ 2 kHz / °C



FLDV-156 bandpass filter

Mechanical & Environmental Specifications		
Dimensions (W x D x H)	320 x 522 x 407 mm	
Weight	27 kg	
Materials	Outer conductor	Copper
	Inner conductor	Silver plated aluminium and brass
	Tuning elements	Invar and silver plated aluminium and brass
	Isolators	PTFE
	Finishing	Long lasting black paint
	Screws	Stainless steel
Temperature range	-10°C to +50°C	

Frequency Responses ⁽²⁾		
Channel bandwidth 8 MHz (typical DVB-T)		
	474 MHz	858 MHz
f_0	≤ 0.3 dB	≤ 0.35 dB
$f_0 \pm 3.8$ MHz	≤ 0.7 dB	≤ 0.9 dB
$f_0 \pm 4.2$ MHz	> 4 dB	> 4 dB
$f_0 \pm 6$ MHz	> 20 dB	> 20 dB
$f_0 \pm 12$ MHz	> 40 dB	> 40 dB
Channel bandwidth 6 MHz (typical ATSC)		
	473 MHz	803 MHz
f_0	≤ 0.35 dB	≤ 0.4 dB
$f_0 \pm 2.69$ MHz	≤ 0.50 dB	≤ 0.55 dB
$f_0 \pm 3$ MHz	≤ 0.55 dB	≤ 0.65 dB
$f_0 \pm 4$ MHz	> 5.5 dB	> 5.5 dB
$f_0 \pm 5$ MHz	> 20 dB	> 20 dB
$f_0 \pm 6$ MHz	> 35 dB	> 35 dB
$f_0 \pm 9$ MHz	> 64 dB	> 55 dB

Optional Accessories
Integrated stainless steel cold plate for liquid cooling
Directional couplers at inputs and output
Unflanged to flanged adapters at input and output
Rack mounted

NOTES:

(1): See section Environmental for an accurate application handling data.

(2): Other frequency response supplied. Please, ask RYMSA RF



UHF band IV-V DTV mask filter
Typical power: 2.5 - 4.7 kW digital
Bandpass filter
Model: FLDV-158

Electrical Specifications	
Filter type	Bandpass coaxial
Order	8 poles with internal feedback
Cavity size	150 mm
Frequency range	470-862 MHz
Mask type	Critical
Impedance	50 Ohm
Channel bandwidth	6, 7, 8 MHz
Maximum power handling ⁽¹⁾	
Without liquid cooling	2500 W (6 & 8 MHz bandwidth)
With optional liquid cooling	4700 W (8 MHz bandwidth) 3000 W (6 MHz bandwidth)
Connectors	Unflanged 1 5/8"
VSWR	≤ 1.15:1
Group delay variation	≤ 600 ns
Thermal stability	≤ 2 kHz / °C



FLDV-158 bandpass filter

Mechanical & Environmental Specifications		
Dimensions (W x D x H)	320 x 672 x 407 mm	
Weight	39 kg	
Materials	Outer conductor	Copper
	Inner conductor	Silver plated aluminium and brass
	Tuning elements	Invar and silver plated aluminium and brass
	Isolators	PTFE
	Finishing	Long lasting black paint
Screws	Stainless steel	
Temperature range	-10°C to +50°C	

Frequency Responses ⁽²⁾		
Channel bandwidth 8 MHz (typical DVB-T)		
	474 MHz	858 MHz
f_0	≤ 0.5 dB	≤ 0.6 dB
$f_0 \pm 3.8$ MHz	≤ 1.4 dB	≤ 1.8 dB
$f_0 \pm 4.2$ MHz	> 13 dB	> 14 dB
$f_0 \pm 6$ MHz	> 30 dB	> 30 dB
$f_0 \pm 12$ MHz	> 55 dB	> 55 dB
Channel bandwidth 6 MHz (typical ISDB-T)		
	473 MHz	803 MHz
f_0	≤ 0.55 dB	≤ 0.75 dB
$f_0 \pm 2.79$ MHz	≤ 1.6 dB	≤ 2.00 dB
$f_0 \pm 3.15$ MHz	> 15 dB	> 15 dB
$f_0 \pm 4.5$ MHz	> 30 dB	> 30 dB
$f_0 \pm 9$ MHz	> 55 dB	> 55 dB

Optional Accessories
Integrated stainless steel cold plate for liquid cooling
Directional couplers at input and output
Unflanged to flanged adapters at input and output
Rack mounted

NOTES:

(1): See section Environment for an accurate applicatio handling data.

(2): Other frequency respo supplied. Please, ask RYMSA

You're reading a preview 

**Unlock full access (pages 69-73)
by uploading documents or with
a 30 day free trial**

[Continue for Free](#)

UHF band IV-V DTV mask channel combiner
Typical power: 300 W digital NB input
Constant impedance diplexer
Model: DPDV-018

Electrical Specifications

Filter type	FLDV-018 (55 mm)	
Order of the bandpass filter	8 poles with internal feedback	
Frequency range	470-862 MHz	
Type	Constant impedance	
Impedance	50 Ohm	
Minimum channel spacing	≥ 0	
Max. power handling (NB/WB/Output) ⁽¹⁾	0.3 / 1.1 / 1.1 kW RMS	
Connectors (NB/WB/Output)	DIN 7/16 (F)	
Channel bandwidth	6, 7, 8 MHz	
VSWR	≤ 1.15:1	
Frequency response (1)	474 MHz	858 MHz
f_0	≤ 1.7 dB	≤ 2.0 dB
$f_0 \pm 3.8$ MHz	≤ 2.9 dB	≤ 4.1 dB
$f_0 \pm 4.2$ MHz	> 8 dB	> 8 dB
$f_0 \pm 6$ MHz	> 40 dB	> 30 dB
$f_0 \pm 12$ MHz	> 55 dB	> 50 dB
Isolation	≥ 30 dB	
Group delay variation	≤ 400 ns	
Thermal stability	≤ 2 kHz / °C	



DPDV-018 constant impedance channel combiner

Mechanical & Environmental Specifications

Dimensions (W x D x H)	483 x 460 x 130 mm	
Materials	Outer conductor	Copper and brass
	Inner conductor	Silver plated brass
	Tuning elements	Silver plated brass
	Isolators	PTFE
	Finishing	Chromatized plating & long lasting black paint
	Screws	Stainless steel
Temperature range	-10°C to +50°C	

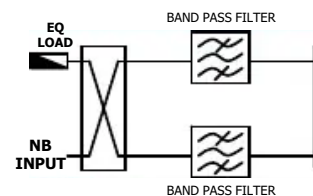

CONSTANT IMPEDANCE CONFIDENTIAL

NOTES:

- (1): See section Environmental an accurate application of power
- (2): Typical specifications for ad Ask RYMSA RF for other cases.

Optional Accessories

Directional couplers and/or fine matchers at inputs and output

The combiner can be field retuned to any frequency within specified band



UHF band IV-V DTV mask channel combiner
Typical power: 1.2 kW, 2 kW digital NB input
Constant impedance diplexer
Models: DPDV-116, DPDV-146, DPDV-146HP, DPDV-146EHP

Electrical Specifications	
Filter type	FLDV-116 (100 mm)
Order of the bandpass filter	6 poles with internal feedback
Frequency range	470-862 MHz
Type	Constant impedance
Impedance	50 Ohm
Minimum channel spacing	≥ 0
Max. power handling (NB/WB/Output) ⁽¹⁾	
DPDV-116	1.2/1.2/1.2 kW RMS
DPDV-146	1.2/2.3/3.5 kW RMS
DPDV-146HP	1.2/5/5 kW RMS
DPDV-146EHP	2/5/5 kW RMS
Connectors (NB/WB/Output)	
DPDV-116	DIN 7/16(F) / DIN 7/16(F) / DIN 7/16(F)
DPDV-146, DPDV-146HP	DIN 7/16(F) / 1 5/8"unflanged / 1 5/8"unflanged
DPDV-146EHP	EIA 7/8"(M) / 1 5/8"unflanged / 1 5/8"unflanged
Channel bandwidth	6, 7, 8 MHz
VSWR	≤ 1.10:1
Isolation	≥ 35 dB
Group delay variation	≤ 350 ns
Thermal stability	≤ 2 kHz / °C



DPDV-146EHP constant 6 poles channel combiner

Mechanical & Environmental Specifications		
Dimensions (W x D x H)	483 x 423 x 448 mm	
Materials	Outer conductor	Copper (filters), Aluminium (rest)
	Inner conductor	Silver plated aluminium and brass
	Tuning elements	Invar, silver plated aluminium and brass
	Isolators	PTFE
	Finishing	Chromatized plating & long lasting paint
	Screws	Stainless steel
Temperature range	-10°C to +50°C	

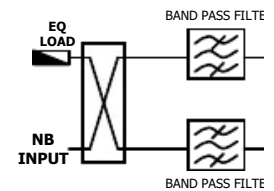

CONSTANT IMPEDANCE DIPLEXER

Frequency Responses		
Channel bandwidth 8 MHz (typical DVB-T) ⁽²⁾		
	474 MHz	858 MHz
f_0	≤ 0.5 dB	≤ 0.65 dB
$f_0 \pm 3.8$ MHz	≤ 1.1 dB	≤ 1.6 dB
$f_0 \pm 4.2$ MHz	> 4 dB	> 4 dB
$f_0 \pm 6$ MHz	> 20 dB	> 20 dB
$f_0 \pm 12$ MHz	> 40 dB	> 40 dB
Channel bandwidth 6 MHz (typical ATSC) ⁽²⁾		
	473 MHz	803 MHz
f_0	≤ 0.55 dB	≤ 0.75 dB
$f_0 \pm 2.69$ MHz	≤ 0.6 dB	≤ 0.85 dB
$f_0 \pm 3$ MHz	≤ 0.65 dB	≤ 0.9 dB
$f_0 \pm 4$ MHz	> 5.5 dB	> 5.5 dB
$f_0 \pm 5$ MHz	> 18 dB	> 18 dB
$f_0 \pm 6$ MHz	> 30 dB	> 30 dB
$f_0 \pm 9$ MHz	> 64 dB	> 64 dB

NOTES:

(1): See section Environment for an accurate application handling data. Other power handling data can be used. Please, ask RYMSA RF.

(2): Typical specifications per channel. Ask RYMSA RF for more details.

Optional Accessories
Directional couplers and/or fine matcher at inputs and output
Unflanged to flanged adapters at output

The combiner can be field retuned to any frequency within specified band



UHF band IV-V DTV mask channel combiner
Typical power: 1.2 kW, 2kW digital NB input
Constant impedance diplexer
Models: DPDV-118, DPDV-148, DPDV-148HP, DPDV-1482E

Electrical Specifications	
Filter type	FLDV-118 (100 mm)
Order of the bandpass filter	8 poles with internal feedback
Frequency range	470-862 MHz
Type	Constant impedance
Impedance	50 Ohm
Minimum channel spacing	≥ 0
Max. power handling (NB/WB/Output) ⁽¹⁾	
DPDV-118	1.2/1.2/1.2 kW RMS
DPDV-148	1.2/2.3/3.5 kW RMS
DPDV-148HP	1.2/5/5 kW RMS
DPDV-1482EHP	2/5/5 kW RMS
Connectors (NB/WB/Output)	
DPDV-118	DIN 7/16(F) / DIN 7/16(F) / DIN 7/16(F)
DPDV-148, DPDV-148HP	DIN 7/16(F) / 1 5/8"unflanged / 1 5/8"unflanged
DPDV-1482EHP	EIA 7/8"(M) / 1 5/8"unflanged / 1 5/8"unflanged
Channel bandwidth	6, 7, 8 MHz
VSWR	≤ 1.10:1
Isolation	≥ 35 dB
Group delay variation	≤ 450 ns
Thermal stability	≤ 2 kHz / °C

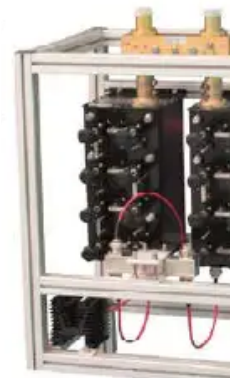

DPDV-148 Constant imp
8 poles channel comb

Mechanical & Environmental Specifications		
Dimensions (W x D x H)	610 x 575 x 900 mm	
Materials	Outer conductor	Copper (filters), Aluminium (rest)
	Inner conductor	Silver plated aluminium and brass
	Tuning elements	Invar, silver plated aluminium and brass
	Isolators	PTFE
	Finishing	Chromatized plating & long lasting paint
	Screws	Stainless steel
Temperature range	-10°C to +50°C	

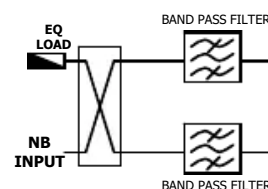

CONSTANT IMPEDANCE CC

Frequency Responses		
Channel bandwidth 8 MHz (typical DVB-T) ⁽²⁾		
	474 MHz	858 MHz
f ₀	≤ 0.60 dB	≤ 0.85 dB
f ₀ ± 3.8 MHz	≤ 2.15 dB	≤ 3.15 dB
f ₀ ± 4.2 MHz	> 15 dB	> 15 dB
f ₀ ± 6 MHz	> 40 dB	> 40 dB
f ₀ ± 12 MHz	> 55 dB	> 55 dB
Channel bandwidth 6 MHz (typical ISDB-T) ⁽²⁾		
	473 MHz	803 MHz
f ₀	≤ 0.70 dB	≤ 1.05 dB
f ₀ ± 2.79 MHz	≤ 2.15 dB	≤ 2.65 dB
f ₀ ± 3.15 MHz	> 15 dB	> 15 dB
f ₀ ± 4.5 MHz	> 35 dB	> 35 dB
f ₀ ± 9 MHz	> 60 dB	> 60 dB

NOTES:

(1): See section Environment an accurate application of pow Other narrowband input powe the same filter type can be t RYMSA RF.

(2): Typical specifications for channel. Ask RYMSA RF for oth

Optional Accessories
Directional couplers and/or fine matcher at inputs and output
Unflanged to flanged adapters at output

The combiner can be field retuned to any frequency within specified band

You're reading a preview 

**Unlock full access (pages 77-85)
by uploading documents or with
a 30 day free trial**

[Continue for Free](#)

VHF band I non mask channel combiner
Typical power : 5 + 10 kW, 20 + 20 kW
Constant impedance diplexer
Models: DP11-230, DP11-240

Electrical Specifications		
Order of the bandpass filters	4	5
Frequency range	54-88 MHz	
Type	Constant impedance	
Impedance	50 Ohm	
Minimum frequency spacing	1 channel guard	Channel 4-5
Max. power handling (NB/WB/Output)		
DP11-230	10/10/15 kW peak sync	
DP11-240	20/20/40 kW peak sync	
Input connectors (NB/WB)		
DP11-230	Unflanged 1 5/8"	
DP11-240	Unflanged 3 1/8"	
Output connector		
DP11-230	Unflanged 1 5/8"	
DP11-240	Unflanged 3 1/8"	
Channel bandwidth	6 MHz	
VSWR	Narrowband input	≤ 1.08:1
	Wideband input	≤ 1.10:1
Insertion loss	Narrowband input	≤ 0.2 dB
	Wideband input	≤ 0.1 dB
Isolation	NB input to WB input	≥ 35 dB
	WB input to NB input	≥ 40 dB
Thermoswitch at EQ load	Yes	

DP11-230 4th order ch:
combiner

Mechanical & Environmental Specifications		
Order of the bandpass filters	4	5
Dimensions (W x D x H)		
DP11-230	1350x1490x1300mm	1350x1690x1300mm
DP11-240	1350x1690x1300mm	1350x1890x1300mm
Materials	Outer conductor	Aluminium
	Inner conductor	Aluminium
	Tuning elements	Aluminium
	Isolators	PTFE
	Finishing	Chromatized plating & long lasting black paint
	Screws	Stainless steel
Temperature range	-10°C to +50°C	

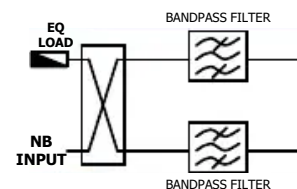

CONSTANT IMPEDANCE CONFIG

Optional Accessories
Unflanged to flanged adapter at inputs and output
Directional couplers at inputs and output ^o



VHF band I non mask channel combiner
Typical power: 20 + 40 kW, 40 + 80 kW
Constant impedance diplexer
Models: DP11-440, DP11-470

Electrical Specifications		
Order of the bandpass filters	3	4
Frequency range	54-88 MHz	
Type	Constant impedance	
Impedance	50 Ohm	
Minimum frequency spacing	1 channel	Channel 4-5
Max. power handling (NB/WB/Output)	40/60/60 kW peak sync 40/120/120 kW peak sync	
Input connectors (NB/WB)	Unflanged 3 1/8"	
	Unflanged 3 1/8"	
Output connector	Unflanged 3 1/8"	
	Unflanged 6 1/8"	
Channel bandwidth	6 MHz	
VSWR	Narrowband input	≤ 1.08:1
	Wideband input	≤ 1.10:1
Insertion loss	Narrowband input	≤ 0.2 dB
	Wideband input	≤ 0.1 dB
Isolation	NB input to WB input	≥ 35 dB
	WB input to NB input	≥ 40 dB
Thermoswitch at EQ load	Yes	



DP11-440 3rd order chann
combiner

Mechanical & Environmental Specifications		
Order of the bandpass filters	3	4
Dimensions (W x D x H)	3150x1420x1900mm	3800x1420x1900mm
Materials	Outer conductor	Aluminium
	Inner conductor	Silver plated aluminium
	Tuning elements	Aluminium
	Isolators	PTFE
	Finishing	Chromatized plating & long lasting black paint
	Screws	Stainless steel
Temperature Range	-10°C to +50°C	

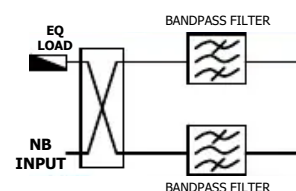

CONSTANT IMPEDANCE CONFIG

Optional Accessories
Unflanged to flanged adapter at inputs and output
Directional couplers at inputs and output



VHF band III non mask channel combiner
Typical power: 500 + 500 W
Constant impedance diplexer
Model: DP13-930

Electrical Specifications

Order of the bandpass filters	5	
Frequency range	174 - 230 MHz	
Type	Constant impedance	
Impedance	50 Ohm	
Recommended minimum freq. spacing	1 guard channel	
Max. power handling (NB/WB/Output)	500/500/1000 W peak sync 350/350/700 W RMS	
Input connectors (NB/WB)	EIA 7/8"	
Output connector	EIA 7/8"	
Channel bandwidth	7 MHz	
VSWR	Narrowband input	≤ 1.08:1
	Wideband input	≤ 1.15:1
Insertion loss	Narrowband input	≤ 0.7 dB
	Wideband input	≤ 0.2 dB
Isolation	NB input to WB input	≥ 35 dB
	WB input to NB input	≥ 40 dB



Mechanical & Environmental Specifications

Dimensions (W x D x H)	470 x 641 x 448 mm	
Materials	Outer conductor	Aluminium
	Inner conductor	Silver plated aluminium and brass
	Tuning elements	Aluminium
	Isolators	PTFE
	Finishing	Chromatized plating
	Screws	Stainless steel
Temperature range	-10°C to +50°C	

The combiner can be field retuned to any channel within specified band

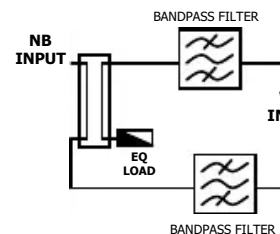

CONSTANT IMPEDANCE COMBINER



VHF band III non mask channel combiner
Typical power: 5 + 5 kW, 10 + 30 kW
Constant impedance diplexer
Model: DP13-230, DP13-240

Electrical Specifications		
Order of the bandpass filters		4
Frequency range		174 - 230 MHz
Type		Constant impedance
Impedance		50 Ohm
Recommended minimum freq. spacing		1 guard channel
Max. power handling (NB/WB/Output)		
DP13-230		10/10/10 kW peak sync, 7/7/7 RMS
DP13-240		10/30/40 kW peak sync, 7/21/28 RMS
Input connectors (NB/WB)		
DP13-230		Unflanged 1 5/8" / Unflanged 1 5/8"
DP13-240		Unflanged 1 5/8" / Unflanged 3 1/8"
Output connector		
DP13-230		Unflanged 1 5/8"
DP13-240		Unflanged 3 1/8"
Channel bandwidth		6 MHz / 7 MHz / 8 MHz
VSWR	Narrowband input	≤ 1.08:1
	Wideband input	≤ 1.10:1
Insertion loss	Narrowband input	≤ 0.25 dB
	Wideband input	≤ 0.2 dB
Isolation	NB input to WB input	≥ 35 dB
	WB input to NB input	≥ 40 dB
Thermoswitch at EQ load		Yes



DP13-230 channel combiner

Mechanical & Environmental Specifications		
Dimensions (W x D x H)		
DP13-230		430 x 665 x 1570 mm
DP13-240		430 x 665 x 1730 mm
Materials	Outer conductor	Aluminium
	Inner conductor	Silver plated aluminium
	Tuning elements	Aluminium
	Isolators	PTFE
	Finishing	Chromatized plating & long lasting black paint
Screws		Stainless steel
Temperature range		-10°C to +50°C

Optional Accessories	
Directional couplers at inputs and output	
Unflanged to flanged adapters at inputs and output	

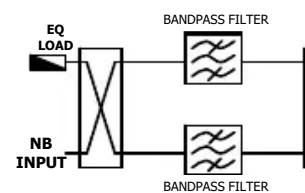

CONSTANT IMPEDANCE CONF

The combiner can be field retuned to any channel within specified band



VHF band III non mask channel combiner
Typical power: 20 + 20 kW, 40 + 80 kW
Constant impedance diplexer
Model: DP13-440, DP13-470

Electrical Specifications

Order of the bandpass filters	4	
Frequency range	174 - 230 MHz	
Type	Constant impedance	
Impedance	50 Ohm	
Recommended minimum freq. spacing	1 guard channel	
Max. power handling (NB/WB/Output)	DP13-440 20/40/40 kW peak sync, 14/28/28 RMS DP13-470 40/80/120 kW peak sync, 28/56/84 RMS	
Input connectors (NB/WB)	DP13-440 Unflanged 3 1/8" / Unflanged 3 1/8" DP13-470 Unflanged 3 1/8" / Flanged 6 1/8"	
Output connector	DP13-440 Unflanged 3 1/8" DP13-470 Flanged 6 1/8"	
Channel bandwidth	6 MHz / 7 MHz / 8 MHz	
VSWR	Narrowband input	≤ 1.08:1
	Wideband input	≤ 1.10:1
Insertion loss	Narrowband input	≤ 0.2 dB
	Wideband input	≤ 0.1 dB
Isolation	NB input to WB input	≥ 35 dB
	WB input to NB input	≥ 40 dB
Thermoswitch at EQ load	Yes	



DP13-440 channel combi

Mechanical & Environmental Specifications

Dimensions (W x D x H)	DP13-440 955 x 1620 x 1110 mm DP13-470 955 x 1620 x 1350 mm	
Materials	Outer conductor	Aluminium
	Inner conductor	Silver plated aluminium
	Tuning elements	Aluminium
	Isolators	PTFE
	Finishing	Chromatized plating & long lasting black paint
Screws	Stainless steel	
Temperature range	-10°C to +50°C	

Optional Accessories

Directional couplers at inputs and output
Unflanged to flanged adapters at inputs and output

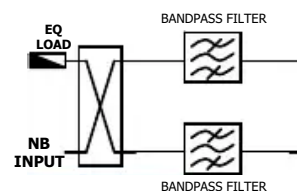

CONSTANT IMPEDANCE CONF

The combiner can be field retuned to any channel within specified band



VHF band III non mask channel combiner
Typical power: 2 x 250 W
Star-point diplexer
Model: DP13-911, DP13-931

Electrical Specifications

Order of the bandpass filters	5
Frequency range	174 - 230 MHz
Type	Star-point
Impedance	50 Ohm
Recommended minimum freq. spacing	2 guard channels
Maximum power handling	2 x 250 W peak sync, 2 x 175 W RMS
Input connectors (NB/WB)	
DP13-911	N (F)
DP13-931	Flanged 7/8"
Output connector	
DP13-911	DIN 7/16 (F)
DP13-931	Flanged 7/8"
Channel bandwidth	7 MHz
VSWR	≤ 1.08:1
Insertion loss	≤ 0.7 dB
Isolation between inputs	≥ 35 dB

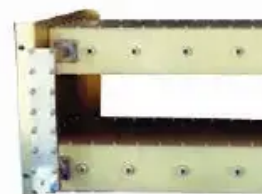

DP13-911 channel co

Mechanical & Environmental Specifications

Dimensions (W x D x H)	266 x 360 x 482 mm	
Materials	Outer conductor	Aluminium
	Inner conductor	Silver plated aluminium and brass
	Tuning elements	Silver plated brass
	Isolators	PTFE
	Finishing	Chromatized plating
	Screws	Stainless steel
Temperature range	-10°C to +50°C	

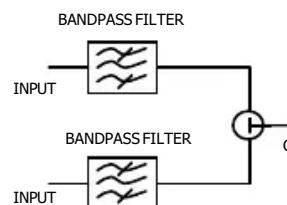

STAR POINT CONFIGURATION

The combiner can be field retuned to any channel within specified band



UHF band IV-V non mask channel combiner
Typical power: 50 + 300 W
Constant impedance diplexer
Model: DP15-02A

Electrical Specifications

Order of the band-pass filter	4	
Frequency range	470-862 MHz	
Type	Constant impedance	
Impedance	50 Ohm	
Recommended min. frequency spacing	1 guard channel	
Max. power handling (NB/WB/Output)	70/300/300 W peak sync 50/200/200 W RMS	
Input connectors	N (F)	
Output connector	N (F)	
Channel bandwidth	6, 7, 8 MHz	
VSWR	Narrowband input	≤ 1.06
	Wideband input	$\leq 1.10:1$
Insertion loss	Narrowband input (1)	≤ 0.9 dB
	Wideband input	≤ 0.05 dB
Isolation	Narrowband input	≥ 30 dB
	Wideband input	≥ 30 dB

Mechanical & Environmental Specifications

Dimensions (W x D x H)	252 x 43 x 152 mm	
Materials	Outer conductor	Aluminium
	Inner conductor	Silver plated aluminium
	Tuning elements	Silver plated aluminium
	Isolators	PTFE
	Finishing	Long lasting black paint
	Screws	Stainless steel
Temperature range	-10°C to +50°C	

Optional Accessories

Directional couplers and/or fine matcher at inputs and output

Structure to install in a 19" rack

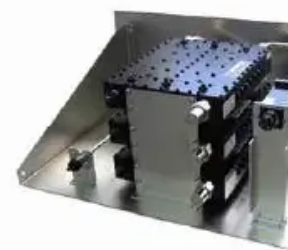

Constant Impedance 4 poles filter
(including structure to install in a
and measurement coupler at th

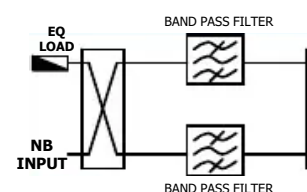

CONSTANT IMPEDANCE CONF

NOTES:

(1): Typical specifications for 8 M
Ask RYMSA RF for other cases.



UHF band IV-V non mask channel combiner
Typical power: 200 + 800 W
Constant impedance diplexer
Model: DP15-12A

Electrical Specifications

Order of the bandpass filter	4	
Frequency range	470-862 MHz	
Type	Constant impedance	
Impedance	50 Ohm	
Minimum frequency spacing (1)	2 guard channels	
Max. power handling (NB/WB/Output)	400/800/1200 W peak sync 280/560/840 W RMS	
Input connectors (2)	DIN 7/16 (F)	
Output connector (2)	DIN 7/16 (F)	
Channel bandwidth	6, 7, 8 MHz	
VSWR	Narrowband input	$\leq 1.07:1$
	Wideband input	$\leq 1.20:1$ (typical $\leq 1.1:1$)
Insertion loss	Narrowband input (3)	≤ 1.2 dB (typical ≤ 0.7 dB)
	Wideband input	≤ 0.2 dB
Isolation	Narrowband input	≥ 26 dB
	Wideband input	≥ 35 dB

DP15-12A 4th order Channel

Mechanical & Environmental Specifications

Dimensions (W x D x H)	220 x 352 x 315 mm	
Materials	Outer conductor	Aluminium and brass
	Inner conductor	Silver plated brass
	Tuning elements	Silver plated brass
	Isolators	PTFE
	Finishing	Chromatized plating
	Screws	Stainless steel
Temperature range	-10°C to +50°C	

The combiner can be field retuned to any channel within specified band

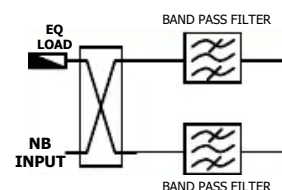

CONSTANT IMPEDANCE COM

NOTES:

- (1): Less than two channel spacing can be achieved but the transmission response fig
- (2): N (F) connector available
- (3): Typical specifications channels. Ask RYMSA RF for

You're reading a preview 

**Unlock full access (pages 94-101)
by uploading documents or with
a 30 day free trial**

[Continue for Free](#)



FM band II channel combiner
Typical power: 10 + 30 kW, 10 + 60 kW
Constant impedance diplexer
Model: DP12-430, DP12-460

Electrical Specifications

	2	3	4
Order of the bandpass filters	2	3	4
Frequency range		87.5-108 MHz	
Type		Constant impedance	
Impedance		50 Ohm	
Recommended minimum freq. spacing (1)	1.2 MHz	0.9 MHz	0.7 MHz
Max. power handling (NB/WB/Output)			
DP12-430		12/40/40 kW	
DP12-460		12/70/70 kW	
Input connectors (NB/WB)			
DP12-430	Unflanged 1 5/8"	Unflanged 3 1/8"	
DP12-460	Unflanged 1 5/8"	Unflanged 4 1/2"	
Output connector			
DP12-430		Unflanged 3 1/8"	
DP12-460		Unflanged 4 1/2"	
VSWR			
Narrowband input	≤ 1.05:1 at carrier fc		
Wideband input	≤ 1.10:1		
Insertion loss			
Narrowband input	≤ 0.20dB (f _c)	≤ 0.26dB (f _c)	≤ 0.32dB (f _c)
Wideband input	≤ 0.1 dB		
NB input to WB input	≥ 40 dB		
Isolation			
WB input to NB input	≥ 50 dB		
Group delay at fc ± 150 kHz	≤ 50 ns	≤ 80 ns	≤ 100 ns
Thermoswitch at EQ load		Yes	

Mechanical & Environmental Specifications

	2	3	4
Order of the bandpass filters	2	3	4
Dimensions DP12-430 (W x D x H)	1052 x 985 x 1520 mm	1052 x 1445 x 1520 mm	1052 x 1905 x 1520 mm
Dimensions DP12-460 (W x D x H)	1052 x 985 x 1520 mm	1052 x 1445 x 1520 mm	1052 x 1905 x 1520 mm
Materials			
Outer conductor	Aluminium		
Inner conductor	Silver plated aluminium		
Tuning elements	Invar and silver plated aluminium		
Isolators	PTFE		
Finishing	Chromatized plating & long lasting black paint		
Screws	Stainless steel		
Temperature range	-10°C to +50°C		

Optional Accessories

- Directional couplers at inputs and output
- Unflanged to flanged adapters at inputs and output
- Bandpass filter on wideband input (2)

The combiner can be field retuned to any frequency within specified band

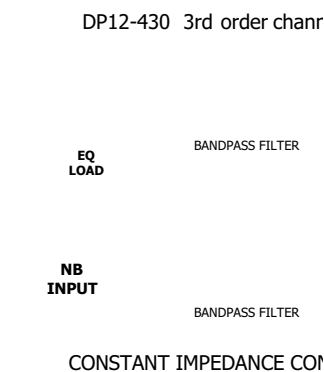

NOTES:

- (1): Each model can achieve a narrower spacing than the one specified, by transmission response figures. 0.7 MHz is available with 4th order and inter-coupled.
- (2): The use of an extra filter between wideband input enhances the isolation between inputs, thus reducing the possibility of inter-modulation products.



FM band II channel combiner
Typical power: 20 + 20 kW, 20 + 50 kW
Constant impedance diplexer
Model: DP12-440, DP12-450

Electrical Specifications				
Order of the bandpass filters		2	3	4
Frequency range	87.5-108 MHz			
Type	Constant impedance			
Impedance	50 Ohm			
Recommended minimum freq. spacing (1)	1.2 MHz	0.9 MHz	0.7 MHz	
Max. power handling (NB/WB/Output)				
DP12-440	25/40/40 kW			
DP12-450	25/70/70 kW			
Input connectors (NB/WB)				
DP12-440	Unflanged 3 1/8" / Unflanged 3 1/8"			
DP12-450	Unflanged 3 1/8" / Unflanged 4 1/2"			
Output connector				
DP12-440	Unflanged 3 1/8"			
DP12-450	Unflanged 4 1/2"			
VSWR	Narrowband input	≤ 1.05:1 at carrier fc		
	Wideband input	≤ 1.10:1		
Insertion loss	Narrowband input	≤0.20dB(fc)	≤0.26dB(fc)	≤0.32dB(fc)
	Wideband input	≤ 0.1 dB		
Isolation	NB input to WB input	≥ 40 dB		
	WB input to NB input	≥ 50 dB		
Group delay at fc ± 150 kHz	≤ 50 ns	≤ 80 ns	≤ 100 ns	
Thermoswitch at EQ load	Yes			

DP12-440 4th order channel

Mechanical & Environmental Specifications				
Order of the bandpass filters		2	3	4
Dimensions DP12-440 (W x D x H)	1055 x 980 x 1653 mm	1055 x 1440 x 1653 mm	1055 x 1900 x 1653 mm	
Dimensions DP12-450 (W x D x H)	1055 x 990 x 1698 mm	1055 x 1450 x 1698 mm	1055 x 1910 x 1698 mm	
Materials	Outer conductor	Aluminium		
	Inner conductor	Silver plated aluminium		
	Tuning elements	INVAR and silver plated aluminium		
	Isolators	PTFE		
	Finishing	Chromatized plating & long lasting black paint		
	Screws	Stainless steel		
Temperature range	-10°C to +50°C			

NOTES:

(1): Each model can achieve channel spacing than the one sacrificing the transmission resp 0.5 MHz spacing available with inter-cavity feedback.

(2): The use of an extra filter the wideband input enhances between inputs, thus reducing generation of inter-mod product

Optional Accessories	
Directional couplers at inputs and output	
Unflanged to flanged adapters at inputs and output	
Bandpass filter on wideband input (2)	

The combiner can be field retuned to any frequency within specified band



FM band II channel combiner
Typical power: 30 + 110 kW
Constant impedance diplexer
Model: DP12-470

Electrical Specifications				
Order of the bandpass filters		2	3	4
Frequency range		87.5-108 MHz		
Type		Constant impedance		
Impedance		50 Ohm		
Recommended minimum freq. spacing (1)		1.2 MHz	0.9 MHz	0.7 MHz
Max. power handling (NB/WB/Output)		30/140/140 kW		
Input connectors (NB/WB)		Unflanged 3 1/8" / Flanged 6 1/8"		
Output connector		Flanged 6 1/8"		
VSWR	Narrowband input	≤ 1.05:1 at carrier fc		
	Wideband input	≤ 1.10:1		
Insertion loss	Narrowband input	≤0.20dB(fc)	≤0.26dB(fc)	≤0.32dB(fc)
	Wideband input	≤ 0.1 dB		
Isolation	NB input to WB input	≥ 40 dB		
	WB input to NB input	≥ 50 dB		
Group delay at fc ± 150 kHz		≤ 50 ns	≤ 80 ns	≤ 100 ns
Thermoswitch at EQ load		Yes		

DP12-470 2nd order channel combiner

Mechanical & Environmental Specifications				
Order of the bandpass filters		2	3	4
Dimensions (W x D x H)		1070 x 1085 x 1890 mm	1070 x 1545 x 1890 mm	1070 x 2005 x 1890 mm
Materials	Outer conductor	Aluminium		
	Inner conductor	Silver plated aluminium		
	Tuning elements	Invar and silver plated aluminium		
	Isolators	PTFE		
	Finishing	Chromatized plating & long lasting black paint		
	Screws	Stainless steel		
Temperature range		-10°C to +50°C		

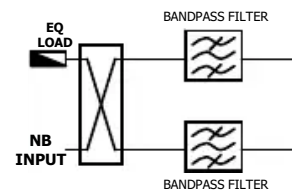

CONSTANT IMPEDANCE COMBINER

Optional Accessories	
Directional couplers at inputs and output	
Unflanged to flanged adapters at inputs and output	
Bandpass filter on wideband input (2)	

The combiner can be field retuned to any frequency within specified band

NOTES:

(1): Each model can achieve channel spacing than the one sacrificing the transmission res 0.5 MHz spacing available with inter-cavity feedback.

(2): The use of an extra filter on wideband input enhances between inputs, thus reducing generation of inter-mod products



FM band II channel combiner
Typical Power: 30 + 270 kW
Constant impedance diplexer
Model: DP12-680

Electrical Specifications				
Order of the bandpass filters		2	3	4
Frequency range		87.5-108 MHz		
Type		Constant impedance		
Impedance		50 Ohm		
Recommended minimum freq. spacing (1)		1.2 MHz	0.9 MHz	0.7 MHz
Max. power handling (NB/WB/Output)		30/300/300 kW		
Input connectors (NB/WB)		Unflanged 3 1/8" / Flanged 9 3/16"		
Output connector		Flanged 9 3/16"		
VSWR	Narrowband input	≤ 1.05:1 at carrier fc		
	Wideband input	≤ 1.10:1		
Insertion loss	Narrowband input	≤0.18dB(fc)	≤0.25dB(fc)	≤0.34dB(fc)
	Wideband input	≤ 0.1 dB		
Isolation	NB input to WB input	≥ 40 dB		
	WB input to NB input	≥ 50 dB		
Group delay at fc ± 150 kHz		≤ 50 ns	≤ 80 ns	≤ 100 ns
Thermoswitch at EQ load		Yes		

Mechanical & Environmental Specifications				
Order of the bandpass filters		2	3	4
Dimensions (W x D x H)		1430 x 1525 x 2150 mm	1430 x 2050 x 2150 mm	1430 x 2640 x 2150 mm
Materials	Outer conductor	Aluminium		
	Inner conductor	Silver plated aluminium		
	Tuning elements	Invar and silver plated aluminium		
	Isolators	PTFE		
	Finishing	Chromatized plating & long lasting black paint		
	Screws	Stainless steel		
Temperature range		-10°C to +50°C		

Optional Accessories	
Directional couplers at inputs and output	
Unflanged to flanged adapters at inputs and output	
Bandpass filter on wideband input (2)	

The combiner can be field retuned to any frequency within specified band



DP12-680 4th order channel combiner with inter-cavity feedback to increase power handling

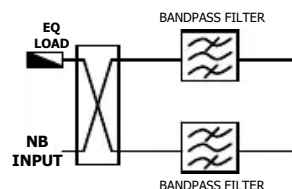

CONSTANT IMPEDANCE COMBINER

NOTES:

(1): Each model can achieve a narrower frequency spacing than the one specified, but with lower transmission response figures. (2): Available with 4th order and inter-cavity feedback.

(2): The use of an extra filter on the wideband input enhances the isolation between the narrowband inputs, thus reducing the possibility of inter-mod products.



FM band II channel combiner

Typical power: 2, 5, 10 kW per input

Star-point combiner

Technical Specifications	
Order of the bandpass filters	2, 3 and 4
Frequency range	87.5-108 MHz
Type	Star-point
Impedance	50 Ohm
VSWR	≤ 1.10:1 at carrier fc
Insertion loss	See table below
Isolation between inputs	≥ 32 dB
Connectors	Unflanged except on DIN 7/16 (see table below)
Temperature range	-10°C to +50°C



HS12-A40-40 S channel

Models								
Max. power per input ⁽¹⁾	Input connectors	Output connector	No. of inputs	Model	Filter order	Freq. spacing ⁽²⁾	Insertion loss at fc	Dimensions Width x Depth x Height
2 kW	DIN 7/16 F or EIA 7/8"	Unflanged 1 5/8"	2	DS12-203-20	2	≥ 2.6 MHz	≤0.35 dB	495 x 460 x 1250 mm
				DS12-203-30	3	≥ 1.5 MHz	≤0.55 dB	495 x 660 x 1250 mm
				DS12-203-40	4	≥ 1.2 MHz	≤0.75 dB	495 x 860 x 1250 mm
			3	TS12-204-20	2	≥ 2.6 MHz	≤0.35 dB	726 x 460 x 1250 mm
				TS12-204-30	3	≥ 1.5 MHz	≤0.55 dB	726 x 660 x 1250 mm
				TS12-204-40	4	≥ 1.2 MHz	≤0.75 dB	726 x 860 x 1250 mm
			4	XS12-204-20	2	≥ 2.6 MHz	≤0.35 dB	1090 x 495 x 1250 mm
				XS12-204-30	3	≥ 1.5 MHz	≤0.55 dB	1490 x 495 x 1250 mm
				XS12-204-40	4	≥ 1.2 MHz	≤0.75 dB	1890 x 495 x 1250 mm
5 kW	Unflanged 1 5/8"	Unflanged 1 5/8"	2	DS12-A30-20	2	≥ 2.2 MHz	≤0.30 dB	815 x 700 x 1400 mm
				DS12-A30-30	3	≥ 1.4 MHz	≤0.45 dB	815 x 1050 x 1400 mm
				DS12-A30-40	4	≥ 1.0 MHz	≤0.60 dB	780 x 1650 x 1400 mm
		3	TS12-A40-20	2	≥ 2.2 MHz	≤0.30 dB	1170 x 700 x 1400 mm	
			TS12-A40-30	3	≥ 1.4 MHz	≤0.45 dB	1170 x 1050 x 1400 mm	
			TS12-A40-40	4	≥ 1.0 MHz	≤0.60 dB	1150 x 1650 x 1400 mm	
		4	XS12-A40-20	2	≥ 2.2 MHz	≤0.30 dB	815 x 1400 x 1400 mm	
			XS12-A40-30	3	≥ 1.4 MHz	≤0.45 dB	815 x 2100 x 1400 mm	
			XS12-A40-40	4	≥ 1.0 MHz	≤0.60 dB	730 x 3300 x 1400 mm	
		6	HS12-A40-20	2	≥ 2.2 MHz	≤0.30 dB	815 x 2120 x 1400 mm	
			HS12-A40-30	3	≥ 1.4 MHz	≤0.45 dB	815 x 3160 x 1400 mm	
			HS12-A40-40	4	≥ 1.0 MHz	≤0.60 dB	1090 x 3300 x 1400 mm	
10 kW	Unflanged 1 5/8"	Unflanged 3 1/8"	2	DS12-430-20	2	≥ 2.0 MHz	≤0.20 dB	970 x 985 x 1350 mm
				DS12-430-30	3	≥ 1.2 MHz	≤0.30 dB	970 x 1450 x 1350 mm
				DS12-430-40	4	≥ 0.9 MHz	≤0.40 dB	970 x 1910 x 1350 mm
			3	TS12-430-20	2	≥ 2.0 MHz	≤0.20 dB	1490 x 985 x 1350 mm
				TS12-430-30	3	≥ 1.2 MHz	≤0.30 dB	1490 x 1450 x 1350 mm
				TS12-430-40	4	≥ 0.9 MHz	≤0.40 dB	1490 x 1910 x 1350 mm
			4	XS12-430-20	2	≥ 2.0 MHz	≤0.20 dB	970 x 1975 x 1350 mm
				XS12-430-30	3	≥ 1.2 MHz	≤0.30 dB	970 x 2895 x 1350 mm
				XS12-430-40	4	≥ 0.9 MHz	≤0.40 dB	970 x 3820 x 1350 mm

XS12-204 using a r of 2nd and 3rd

Optional Accessories

Directional couplers at inputs and output

Unflanged to flanged adapters at inputs and outputs



RF passive components and accessories

RYMSA RF manufactures an assorted range of 50 ohm passive components and accessories complement the wide range of solutions for radio and TV antenna systems, filters and channel combiners, enabling supply of complete turnkey RF systems including any possible element existing beyond the transmitter outputs broadcast transmission facilities.

RYMSA RF passive components and accessories can be classified in the following categories:

- Rigid transmission line of several sizes for the interconnection of RF systems, including the inner and conductor tubes and the basic associated accessories:
 - Unflanged elbows
 - Inner and outer coupling elements
 - Typical adapters
- Accessories and components for antenna systems:
 - Connectors for coaxial cables
 - Gas Barriers
 - Outdoor fine matchers
 - Outdoor flanged elbows
- Accessories for indoor equipments:
 - Indoor fine matchers
 - Measurement couplers
 - 3 dB hybrids
- Switch devices:
 - Manual patch panels
 - Motorized coaxial switches
 - Patch panel / dividers
 - Coaxial switch / dividers



1 5/8" Transmission line

RYMSA RF supplies 50 Ohm unflanged 1 5/8" rigid line sections for indoor applications. The inner conductor is made in copper, and the outer conductor can be supplied either made in aluminium or in copper. Crossed isolators made of two PTFE rods are available to achieve the alignment between the two conductors, ensuring minimum VSWR contribution to the line performance by applying the relative spacing directions supplied below.

RYMSA RF also manufactures the related rigid coaxial accessories such as rigid line coupling elements, devices that enable the connection between sections of unflanged rigid line, PTFE crossed isolators, coupling elements, unflanged elbows, inner connectors and unflanged to flanged adapters.

Both the rigid line and the corresponding accessories are manufactured optimizing the VSWR and insertion loss values.

Rigid line conductors

Frequency range	DC-3260 MHz				
Impedance	50 Ohm				
Maximum power handling ⁽¹⁾	70 MHz 19.0 KW	100 MHz 16.0 KW	200 MHz 11.3 KW	500 MHz 7.2 KW	800 MHz 5.7 KW
RF Peak Voltage at sea level	5.2 KV				
Insertion loss (dB/100m) ⁽²⁾	70 MHz 0.51	100 MHz 0.61	200 MHz 0.90	500 MHz 1.37	800 MHz 1.74
Maximum Length section	5 m				
Materials	Outer conductor	Aluminium or copper			
	Inner conductor	Copper			
Temperature range	-10°C to +50°C				

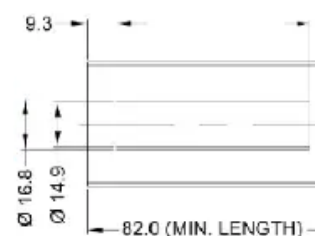

Line Size	Conductor	Material	Reference
1 5/8"	Inner	Copper	1123105800
1 5/8"	Outer	Copper	1123114100
1 5/8"	Outer	Aluminium	1253105800

⁽¹⁾ This value is referred to ambient temperature of +40°C and VSWR 1.0

⁽²⁾ This value is referred to ambient temperature of +20°C

Unflanged coupling elements

These elements enable the connection between two unflanged rigid line sections

Model	Description
LR22-570 / 5013	1 5/8" unflanged inner coupling element
LR22-473 / 5019	1 5/8" unflanged outer coupling element for Al line
LR22-473 / 5074	1 5/8" unflanged outer coupling element for Cu line

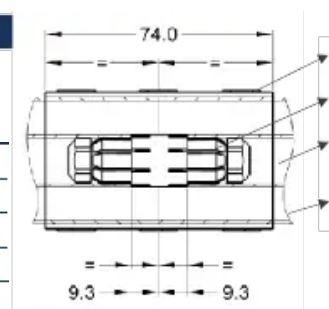

Crossed isolators

These elements enable the alignment between the two conductors ensuring minimum VSWR

Model LR22-090	VHF (BI/II/III)	500 MHz	600 MHz	700 MHz	800 MHz
A	350	350	350	350	350
B	1200	1200	1200	1200	1200
C	100	150	125	107	94

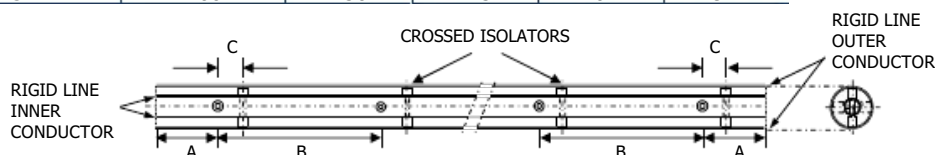

NOTE: INNER CONDUCTOR HAS TO BE DRILLED WITH THE TOOL COMPOSED BY THE PIECES CQ 3036 003 0 AND CQ 3036 004 0

You're reading a preview 

**Unlock full access (pages
109-110) by uploading
documents or with a 30 day free
trial**

[Continue for Free](#)

Unflanged elbow

This element enables a direct connection to the rigid line conductor without using additional coupling elements

Model	CD24-010	
Frequency range	DC-862 MHz	
Impedance	50 Ohm	
VSWR	<1.03:1	
Insertion loss	Negligible	
Max. Power and voltage	According to line size	
Materials	Outer conductor	Aluminium
	Inner conductor	Brass
	Isolator	PTFE
	Finishing	Chromatized plating
Temperature range	-10°C to +50°C	

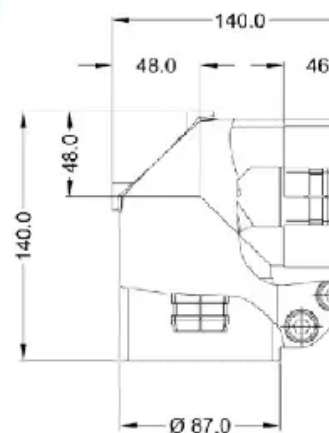

Inner connector

This element enables the connection between two standard EIA flanged coaxial transmission line terminations.

Model	LR24-600	
Max. Power and voltage	According to line size	
Materials	Conductor	Brass
	Isolator	PTFE
	Finishing	White brass
Temperature range	-10°C to +50°C	

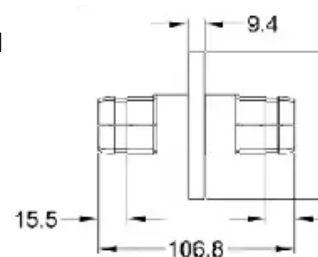

Unflanged to flange adaptor

This element enables provides a standard flanged EIA termination to an unflanged rigid line section

Model	TR24-125	
Frequency range	DC-862 MHz	
Impedance	50 Ohm	
VSWR	<1.03:1	
Insertion loss	Negligible	
Max. Power and voltage	According to line size	
Materials	Outer Conductor	Aluminium
	Finishing	Chromatized plating
Temperature range	-10°C to +50°C	

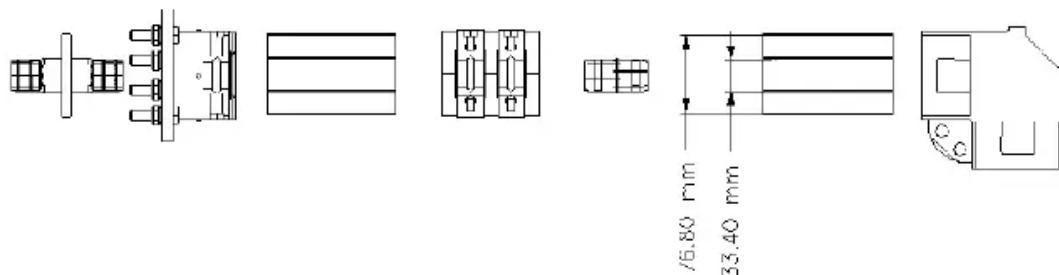
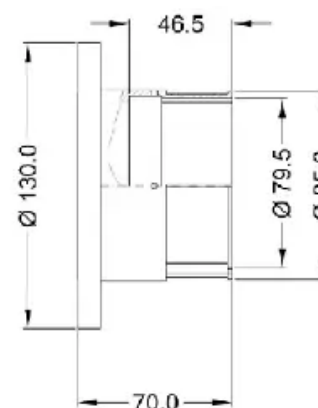

Assembling diagram for 3 1/8" elements

4 1/2" Transmission line

RYMSA RF supplies 50 Ohm unflanged 4 1/2" rigid line sections for indoor applications. The inner conductor is made in copper, and the outer conductor is made in aluminium. Crossed isolators made of two PTFE rods are available to achieve the alignment between the two conductors, ensuring minimum VSWR contribution to the performance by applying the relative spacing directions supplied below.

RYMSA RF also manufactures the related rigid coaxial accessories such as rigid line coupling elements, devices that enable the connection between sections of unflanged rigid line, PTFE cross isolators, coupling elements, unflanged elbows, inner and adapters.

Both the rigid line and the corresponding accessories are manufactured optimizing the VSWR and insertion loss values.

Rigid line conductors

Frequency range	DC-1226 MHz				
Impedance	50 Ohm				
Maximum power handling ⁽¹⁾	70 MHz 105 KW	100 MHz 87.8 KW	200 MHz 62.1 KW	500 MHz 39.3 KW	800 MHz 31.0 KW
RF Peak Voltage at sea level	12.5 KV				
Insertion loss (dB/100m) ⁽²⁾	70 MHz 0.19	100 MHz 0.23	200 MHz 0.33	500 MHz 0.52	800 MHz 0.65
Maximum Length section	5 m				
Materials	Outer conductor		Aluminium		
	Inner conductor		Copper		
Temperature range	-10°C to +50°C				

Line Size	Conductor	Material	Reference
4 1/2"	Inner	Copper	1123114120
4 1/2"	Outer	Aluminium	1253111300

⁽¹⁾ This value is referred to ambient temperature of +40°C and VSWR 1.0

⁽²⁾ This value is referred to ambient temperature of +20°C

⁽³⁾ Unflanged Coupling Elements

These elements enable the connection between two unflanged rigid line sections

Model	Description
LR30-570 / 5157	4 1/2" unflanged inner coupling element
LR30-473 / 5151	4 1/2" unflanged outer coupling element

Ou

Inr

Rig
coiRig
coi

Crossed Isolators

These elements enable the alignment between the two conductors ensuring minimum VSWR

Model LR30-090	VHF (BI/II/III)	500 MHz	600 MHz	700 MHz	800 MHz
A	500	500	500	500	500
B	2000	2000	2000	2000	2000
C	100	150	125	107	94

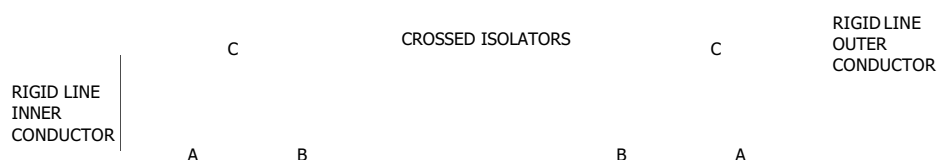

NOTE: INNER CONDUCTOR HAS TO BE DRILLED WITH THE TOOL COMPOSED BY THE PIECES CQ 3036 003 0 AND CQ 3036 004 0

Unflanged elbow

This element enables a direct connection to the rigid line conductor without using additional coupling elements

Model	CD30-010
Frequency range	DC-862 MHz
Impedance	50 Ohm
VSWR	<1.03:1
Insertion loss	Negligible
Max. Power and voltage	According to line size
Materials	Outer conductor Aluminium
	Inner conductor Brass
	Isolator PTFE
	Finishing Chromatized aluminium
Temperature range	-10°C to +50°C

Inner connector

This element enables the connection between two standard EIA flanged coaxial transmission line terminations

Model	LR30-600
Max. Power and voltage	According to line size
Materials	Conductor Brass
	Isolator PTFE
	Finishing White brass
Temperature range	-10°C to +50°C

Unflanged to flange adaptor

This element provides a standard flanged EIA termination to an unflanged rigid line section

Model	TR30-131
Frequency range	DC-862 MHz
Impedance	50 Ohm
VSWR	<1.03:1
Insertion loss	Negligible
Max. Power and voltage	According to line size
Materials	Outer Conductor Aluminium
	Finishing Chromatized plating
Temperature range	-10°C to +50°C

6 1/8" Transmission line

RYMSA RF supplies 50 Ohm unflanged 6 1/8" rigid line sections for indoor applications. The inner conductor is made in copper, and the outer conductor is made in aluminium. Crossed isolators made of two PTFE rods are available to achieve the alignment between the two conductors, ensuring minimum VSWR contribution to the performance by applying the relative spacing directions supplied below. The outer conductor can be supplied either as such or with a standard EIA flanged factory welded.

RYMSA RF also manufactures the related rigid coaxial accessories such as rigid line coupling elements, devices to enable the connection between sections of unflanged rigid line, PTFE cross isolators, coupling elements, unflanged elbows, inner and adapters.

Both the rigid line and the corresponding accessories are manufactured optimizing the VSWR and insertion loss values.

Rigid line conductors

Frequency range	DC-830 MHz				
Impedance	50 Ohm				
Maximum power handling ⁽¹⁾	70 MHz 211 KW	100 MHz 176 KW	200 MHz 125 KW	500 MHz 79 KW	800 MHz 62 KW
RF Peak Voltage at sea level	17.9 KV				
Insertion loss (dB/100m) ⁽²⁾	70 MHz 0.13	100 MHz 0.16	200 MHz 0.22	500 MHz 0.35	800 MHz 0.44
Maximum Length section	5 m				
Materials	Outer conductor	Aluminium or copper			
	Inner conductor	Copper			
Temperature range	-10°C to +50°C				

Line Size	Conductor	Material	Reference
6 1/8"	Inner	Copper	1123119450
6 1/8"	Outer	Aluminium	1253112100
6 1/8"	Outer with one welded flanged	Aluminium	LR26-313

⁽¹⁾ This value is referred to ambient temperature of +40°C and VSWR 1.0

⁽²⁾ This value is referred to ambient temperature of +20°C

Flanged Elbow

This element enables a direct connection to a rigid line standard Flanged EIA termination

Model	CD26-200	
Frequency range	DC-830 MHz	
Impedance	50 Ohm	
VSWR	<1.03:1	
Insertion loss	Negligible	
Max. Power and voltage	According to line size	
	Outer conductor	Aluminium
	Inner conductor	Silver plated brass
Materials	Isolator	PTFE
	Finishing	Chromatized plating
Temperature range	-10°C to +50°C	

You're reading a preview 

**Unlock full access (pages
115-129) by uploading
documents or with a 30 day free
trial**

[Continue for Free](#)

Coaxial switch / divider For dual feed line antenna systems

These devices basically consist of two motorized coaxial switches and one divider, and they are widely utilized on antenna systems fed by two feeder lines.

The mentioned elements are presented in a unitised frame, interconnected in a way that enables the three operative configurations of the antenna system by means of the proper selection of the coaxial switch positions: either the total system working or each of the two half sections separately.

A control unit is included to govern the states of the switches and to supply the necessary interlock service.

The control and supervision of the coaxial switch / divider is done by means of a front panel with buttons and LED displays showing the current antenna configuration, and it also can be done by use of the remote interface.



Electrical Specifications

Impedance	50 Ohm
Frequency range and bandwidth	See models table
VSWR	TV VHF & FM: < 1.05:1
	TV UHF: < 1.10:1 (A1+A2) < 1.07:1 (A1, A2)
Insertion loss	< 0.1 dB
Amplitude split	TV VHF & FM: - 3 +/- 0.2 dB TV UHF: -3 +/- 0.25 dB
Phase split	0° +/- 2° (TV VHF & FM) 0° +/- 3° (TV UHF)
Input/output connectors	EIA 1 5/8" & 3 1/8": Unf. female EIA 6 1/8": Flanged female
Maximum power handling	According to line size
Motor voltage	220 VAC

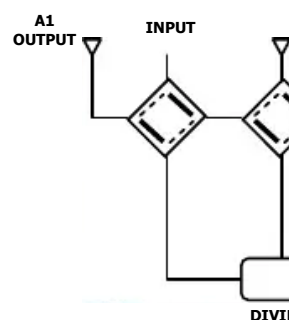

COAXIAL SWITCH / DIVIDER (

Mechanical & Environmental Specifications

Materials	Outer conductor	Aluminium and brass
	Inner conductor	Silver plated aluminium and copper
	Isolators	PTFE
	Finishing	Chromatized plating and long lasting paint
	Screws	Stainless steel
Temperature range	-10°C to + 50°C	



Coaxial switch / divider For dual feed line antenna systems

Models				
Frequency Range	Coaxial size EIA 1 5/8"	Coaxial size EIA 3 1/8"	Coaxial size EIA 4 1/2"	Coaxial size EIA 6 1/8"
FM BII	CC12-231	CC12-261	CC12-241	CC12-281
TV VHF BIII	CC13-231	CC13-261	CC13-241	CC13-281
DAB VHF BIII	CC14-231	CC14-261	CC14-241	CC14-281
TV UHF BIV-V	CC15-231	CC15-261	CC15-241	-----
470-750 MHz	-----	-----		CC15-281

Optional Accessories

Directional couplers at inputs and output

Adapters at inputs and output



B IV-V 4 1/2" Coaxial Switch /Divider
special configuration

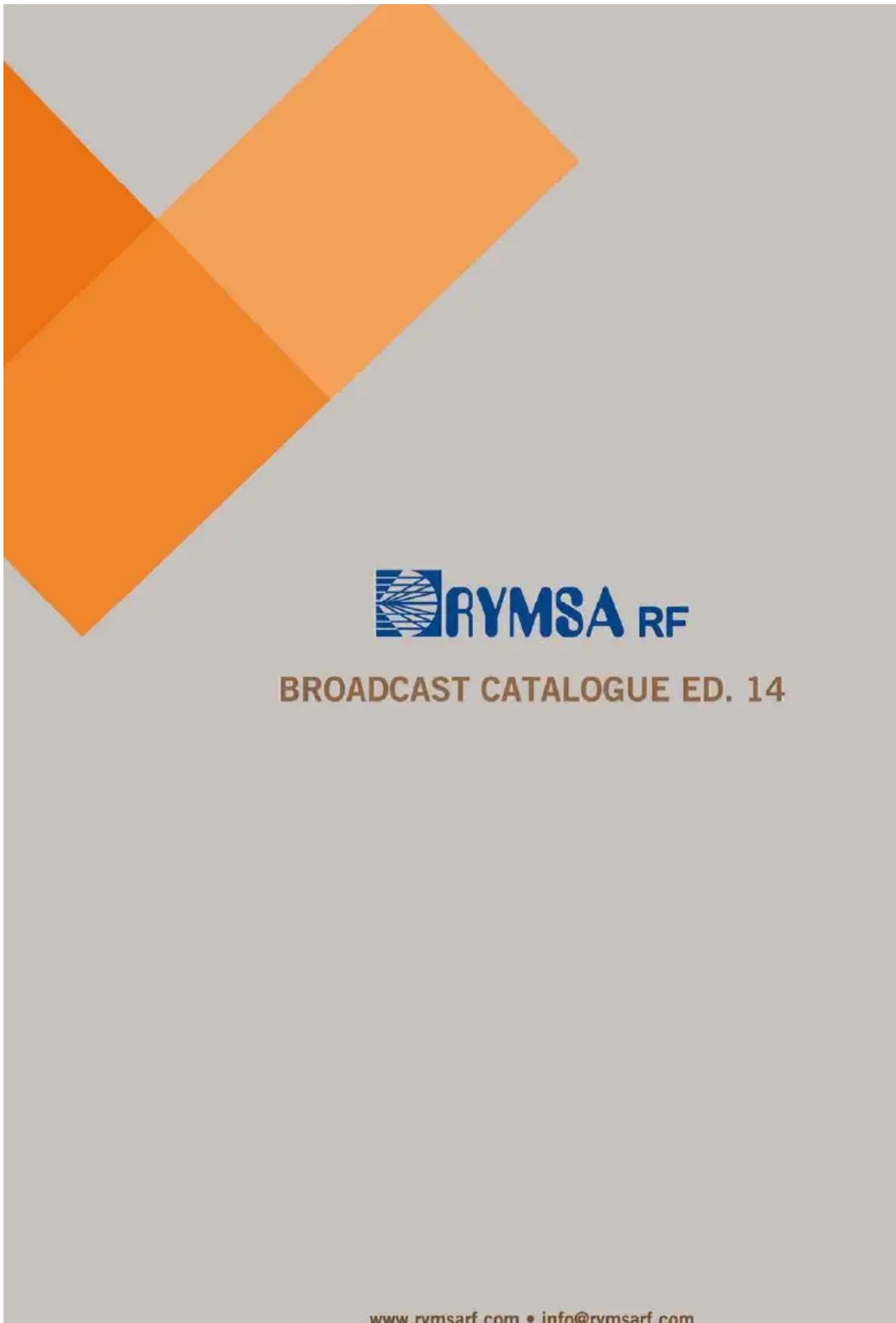

Read free for 30 days

Cancel Anytime



Share this document



You might also like



Antentop 2014-01

Black Onion



00076330

ajay



Antenna and Microwave Lab Manual 2009

Yonas Biniam

Antenna (Radio)

Very High Frequency

Wireless

Telecommunications Engineering



Antenna
Prakash Panda



Improved Impedance Bandwidth
Kiran Patel



ring coupler
bsbsingh71



CATALOGO MOYANO
Jon Csf



richa_g_t



Antenna-Fundamentals.pdf

Ralph Jayson Silang



Stealth Antennas

blackbeast8



Dts-pcd010-V2-4 Dcs1800 Twin Mimo in-band Combiner

dmneylon



7217.03

ken130104



REMOTE SENSING NOTES - Dr.moustafa M.youssef - Assiut Science Fac

I Nyoman Sutyanawan



01-BTS Product Description

Quach Dinh Nhan



DSH-200115-001

Arthur Gomes Soares



telephony-lecture.pdf

von kervy onrade



Dr-Pritam Singh Bakariya



CSH-6516A-VT.pdf

fima ektika



3.1 Antenna Splitter_6

juan



AccessoriesCatalog

Publio Moreno



EFFECT OF SUBSTRATE THICKNESS AND PERMITTIVITY ON PATCH ANTENNA_vikas rathi

Vikasrathi Rathi



SCRIBD



Read free for 30 days



Nayeemuddin Khadri

**S8 K ID DRX EXTN**

Ramesh Kumar

**2. Tower Knowledge**

DATIVA

**9. TD-LTE RNP Engineering Parameter**

DATIVA

**50018807 Itm Guia Rapida Tds 600 Tipo4 Ed1 Esp**

camel2003



Jrc Corral

**6. Huawei LMT & M2000 User Experience**

DATIVA

**Line Trap_Technical Specification**

abhi120783

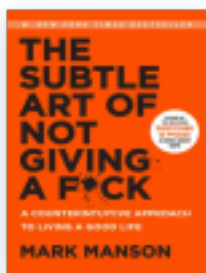
**The Subtle Art of Not Giving a F*ck: A Counterintuitive Approach to Living a Good Life**

Mark Manson

**The Yellow House: A Memoir (2019 National Book Award Winner)**

Sarah M. Broom



SCRIBD



Read free for 30 days



Phil Knight



Hidden Figures: The American Dream and the Untold Story of the Black Women Mathematicians Who Helped Win the Space Race

Margot Lee Shetterly



The Little Book of Hygge: Danish Secrets to Happy Living

Meik Wiking

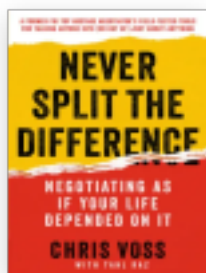

Never Split the Difference: Negotiating As If Your Life Depended On It

Chris Voss

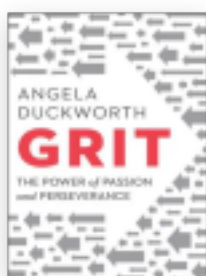

Grit: The Power of Passion and Perseverance

Angela Duckworth



Ashlee Vance

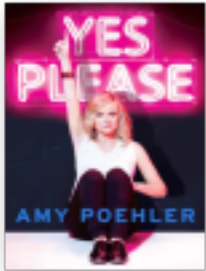

Yes Please

Amy Poehler



A Heartbreaking Work Of Staggering Genius: A Memoir Based on a True Story

Dave Eggers



On Fire: The (Burning) Case for a Green New Deal

Naomi Klein

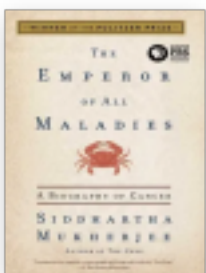

The Emperor of All Maladies: A Biography of Cancer

Siddhartha Mukherjee



Dawn of a New America

Gilbert King



The Hard Thing About Hard Things: Building a Business When There Are No Easy Answers

Ben Horowitz



Team of Rivals: The Political Genius of Abraham Lincoln

Doris Kearns Goodwin

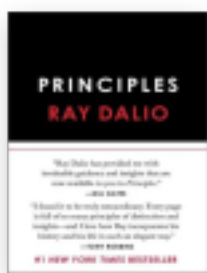

Principles: Life and Work

Ray Dalio



Fear: Trump in the White House

Bob Woodward



Stephen King

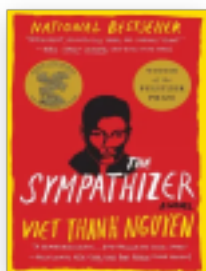

The Sympathizer: A Novel (Pulitzer Prize for Fiction)

Viet Thanh Nguyen



The Handmaid's Tale

Margaret Atwood



The Light Between Oceans: A Novel

M.L. Stedman



The Alice Network: A Novel

Kate Quinn



Ruth Ware

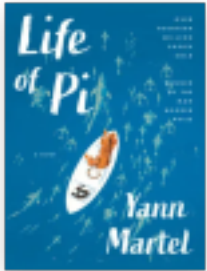

Life of Pi
Yann Martel



Brooklyn: A Novel
Colm Toibin



A Man Called Ove: A Novel
Fredrik Backman



Bel Canto
Ann Patchett



Hilary Mantel



The Perks of Being a Wallflower

Stephen Chbosky



Manhattan Beach: A Novel

Jennifer Egan



Little Women

Louisa May Alcott

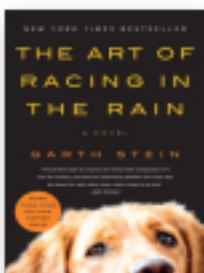

The Art of Racing in the Rain: A Novel

Garth Stein



Betty Smith



The Lord of the Rings: One Volume

J. R. R. Tolkien

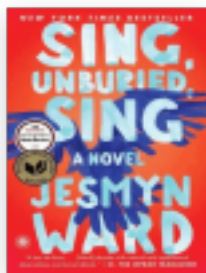

Sing, Unburied, Sing: A Novel

Jesmyn Ward



Everything Is Illuminated

Jonathan Safran Foer



Her Body and Other Parties: Stories

Carmen Maria Machado



John le Carré



Mazda Cy Vm4290a

ani husein



2 MINI DC UPS

Najum



6125HF070.pdf

KeivinMC



TI00404FEN_1311

FREDDY



antonio



TIÊU CHUẨN THIẾT KẾ-All-in-Electrical-Design

Anh Nho



Ece-V-microwaves and Radar Notes

Rethumon Rethu



bt1.0

Synthesis movie clip or all video or



Torsional Modal Shop

Ewdes Hernandez



SCRIBD



Read free for 30 days



imsayaa

**Wang 2016**

Arjun

**Tutorial 2.pdf**

Yong Yee

**Minor Project-Silicon Nanowire Solar Cell**

Aparajita Mallick Sarkar

**USB-FBLMCB User's Manual**

Zeljko Krivokuca



SCRIBD



Read free for 30 days



malord958

**How residential energy storage could help support the power grid - McKinsey - March 2019.pdf**

Sergey Varnavskiy

**Cable - Awg & Mm**

marolopsitohang

**Matlab Simulation**

Donatus Ogalue

**GID 208 ME GAF DS 50322 Raw Water Motor Datasheet R2 Cat 2**

Santoshkumar Gupta



SCRIBD



Read free for 30 days



gcn575

**WPS ISO 15609 Template**

Satish Keskar

**Science-Grade-8.-ACTIVITIES-in-Science-BNHS**

Kenneth Cruz

**copeland-cr42k6-pfv- recip-compressor-technical specifications**

carlosmochima

**AC Saveris Wireless Probes Datasheet**

esterbuttercup



Shairaj Shahar



Cat 272D GSL Skid Steer Loader Electrical Schematic

Keron Trotz



DRM163.pdf

Andres Baena Zuluaga



EC 1 notes.pdf

parantn

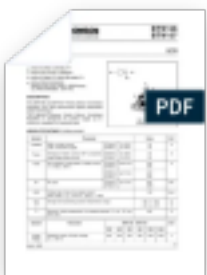

Btw 67

IvanSantiagoP



About Scribd

Press

Our blog

Join our team!

Contact us

Invite friends

Gifts

Scribd for enterprise

Get our free apps

jose_mario1128

Help / FAQ

Accessibility

Purchase help

AdChoices

Publishers

Terms

Privacy

Copyright

Cookie Preferences

 Instagram

 Twitter

 Facebook

 Pinterest

Books • Audiobooks • Magazines • Podcasts • Sheet Music • Documents • Snapshots • Directory

Language: **English** ▼

Copyright © 2022 Scribd Inc.